

## Rechargeable Li-ion Battery Storage System GE-F240 Series

---

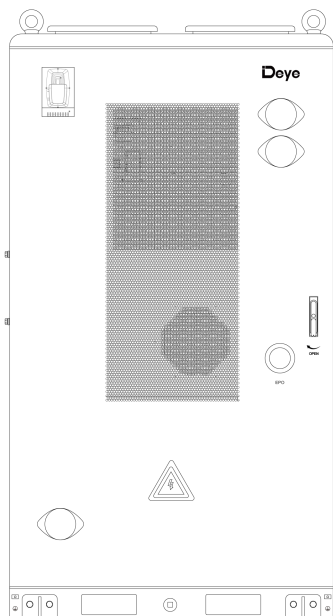

# Preface

This manual provides information on safety, installation, electrical connection, operation, maintenance, and other relevant aspects of the product.

In this manual, the terms “equipment”, “device”, and “product” refer to the product or its components; the terms “manufacturer”, “producer”, and “the Company” refer to NINGBO DEYE ESS TECHNOLOGY CO., LTD. (hereinafter referred to as the “Company”) or its authorized agents.

The illustrations in this manual are for reference only and may differ from the actual product. The Company reserves the right to modify the content without prior notice. For the latest version, please visit our official website or contact our after-sales service.

The Company assumes no liability for any losses arising outside the scope of the warranty policy.

## Copyright



Copyright © 2026 NINGBO DEYE ESS TECHNOLOGY CO., LTD. All Rights Reserved.

No part of this manual may be reproduced, distributed, modified, or translated in any form or by any means without the prior written permission of the Company.

## Trademarks

All DEYE trademarks used in this manual in any form are the property of the Company. Any other trademarks, registered trademarks, logos or service marks mentioned in this manual are the property of their respective owners.

## Convention

Symbols	Description
 <b>DANGER</b>	Indicates an imminently hazardous situation which, if not avoided, will result in death or serious injury.
 <b>WARNING</b>	Indicates a potentially hazardous situation which, if not avoided, could result in death or serious injury.
 <b>CAUTION</b>	Indicates a potentially hazardous situation which, if not avoided, could result in minor or moderate injury.
<b>NOTE</b>	Indicates supplementary explanation, clarification, or emphasis on a particular content for better understanding.



NINGBO DEYE ESS TECHNOLOGY CO., LTD. hereby confirms that the products described in this document comply with the fundamental requirements and other relevant provisions of the applicable EU directives.

## Technical Assistance

### NINGBO DEYE ESS TECHNOLOGY CO., LTD

Address: 6F No.8 building, No.568 Rixian South Road, Cixi Binhai Economic Development Zone, Zhejiang, P.R. China

Tel.: 0086 0574-63702591

E-mail: [service-ess@deye.com.cn](mailto:service-ess@deye.com.cn)

Website: [www.deyeess.com](http://www.deyeess.com)















# Contents











1 Safety.....	1
1.1 Symbols.....	1
1.2 Safety Precautions.....	2
2 Product Introduction.....	6
2.1 Product Overview.....	6
2.2 Application Scenarios.....	6
2.3 Product Appearance.....	7
2.4 Internal Structure.....	10
2.4.1 Battery Pack.....	12
2.4.2 PDU.....	13
2.4.3 Air Conditioner.....	15
2.4.4 Fire Suppression System.....	16
3 Transportation.....	18
3.1 Safety Precautions.....	18
3.2 Transportation Methods.....	20
3.2.1 Forklift.....	20
3.2.2 Hoisting.....	21
4 Installation.....	24
4.1 Pre-Installation Preparation.....	24
4.1.1 Site Requirements.....	24
4.1.2 Foundation Requirements.....	27
4.1.3 Tool Requirements.....	29
4.2 Packing List.....	32
4.3 Installation Procedures.....	35
4.3.1 Install Cabinet Mounting Feet.....	35
4.3.2 Install the Insect Screen.....	37
4.3.3 Install the Inverter.....	38
4.3.4 Install the Cable Cover.....	46
5 Electrical Connection.....	49
5.1 Safety Precautions.....	49
5.2 Open the Cabinet Door.....	50
5.3 Cable Connection.....	50
5.3.1 Preparation.....	50
5.3.2 Grounding.....	51
5.3.3 Communication Cable.....	52

5.3.4 Power Cable .....	52
5.3.5 Auxiliary Power Connection .....	53
5.4 Multi-System Connection .....	56
5.4.1 Communication Between Cabinets .....	56
5.4.2 Power Transfer .....	56
5.5 Post Connection Procedures .....	59
5.5.1 Complete Cable Cover Installation .....	59
5.5.2 Install the MSD .....	60
5.5.3 Apply Fire-Proof Mud .....	60
6 Operation .....	61
6.1 Check Before Power-On .....	61
6.2 Power-On .....	62
6.3 Power-Off .....	64
6.3.1 Normal Power-Off Procedure .....	64
6.3.2 Emergency Power-Off Procedure .....	64
7 Product Monitoring .....	65
7.1 DEYE Cloud Website .....	65
7.2 DEYE Cloud APP .....	65
8 Maintenance .....	66
8.1 Safety Precautions .....	66
8.2 Maintenance Schedule .....	67
8.3 Post-Maintenance Requirements .....	69
8.4 Storage .....	69
9 Technical Specifications .....	71
Appendix I Troubleshooting .....	72
Appendix II Emergency Handling .....	75
Appendix III Declaration of Conformity .....	78
Appendix IV Electrochemical Performance and Durability Parameters .....	79

# 1 Safety

## 1.1 Symbols

Symbols	Description
	Connect an earth terminal to the ground
	General warning
	Warning; Hot surface
	Warning; Electricity
	No stepping on surface
	5 min remaining before operation
	Symbol for separate collection of batteries
	Refer to instruction manual/booklet.
	Operator's manual
	No chasing
	No open flame; Fire, open ignition source and smoking prohibited
	Do not touch
	Do not step on the equipment
	General symbol for recovery/recyclable
	Warning; Explosive material

	Polarity
	This way up
	Fragile, handle with care
	Keep away from rain
	Do not roll
	Do not stack
	Class 9 Miscellaneous Dangerous Goods Label for Lithium ion Batteries
	Insert the forklift forks at the position indicated.
	Center of gravity
	CE mark of conformity

## 1.2 Safety Precautions

### Personal safety



#### **DANGER**

- Keep the battery storage system out of reach of children and animals.
- Only personnel authorized by the company are permitted to repair or disassemble the system. Unauthorized operations may cause fatal electric shock.



#### **WARNING**

- Wiring and electrical connections must be performed by personnel with knowledge of electronics, electrical wiring, and mechanics, and who are familiar with the electrical and mechanical schematics of this equipment.
- In case of electrolyte contact with eyes or skin, flush thoroughly with clean water for at least 10 minutes and seek immediate medical attention.



### **CAUTION**

- Personnel planning to install, operate, or maintain this equipment must:
  - Read, understand and strictly comply with all safety instructions specified in this manual and relevant document.
  - Follow applicable local standards and regulations.
  - Be qualified professionals or trained personnel (as defined in the NOTE below).
- Avoid direct contact with equipment components to prevent scalding caused by high temperatures generated during malfunction.

### **NOTE**

- Qualified professionals: Personnel familiar with the working principles and structure of the equipment, who have received training or have operation experience, and are fully aware of the sources and risk levels of potential hazards during equipment installation, operation and maintenance.
- Trained personnel: Personnel who have completed technical and safety training, have qualified practical operation experience, are aware of potential hazards to themselves and others during specific operations, and are capable of taking protective measures to minimize those hazards.

## **Electrical Safety**



### **DANGER**

- Dangerous lethal high voltage is present inside the unit. Contact with live terminals and internal charged parts will result in fatal electric shock.



### **WARNING**

- Before any installation, maintenance or inspection work, cut off and isolate all external and internal power sources. Confirm the unit is fully de-energized before operation.
- The battery may retain charge even after power disconnection. Wait for at least 5 minutes and verify zero voltage with a standard professional voltmeter before any operation.
- The battery system must be reliably grounded with a grounding resistance of less than 1Ω.
- During all operations, use insulated tools and wear personal protective equipment. Remove all metal accessories such as watches and rings.
- Keep terminals away from exposed wires and metal objects.
- Do not place any tools or metal parts on the battery module or high-voltage

control box.

- All adjacent exposed live parts must be fully covered and shielded with insulating materials.
- Connecting batteries of different models is strictly prohibited.



**CAUTION**

- Ensure correct wiring. Distinguish positive and negative poles strictly to prevent short circuits with external devices.
- Direct connection of the system to AC power or PV solar wiring is strictly prohibited.
- Do not use faulty or incompatible power conversion equipment.
- Verify that battery system parameters are fully compatible with connected equipment.

## Mechanical Safety



**DANGER**

- Installation or operation of the battery system in explosive or high-humidity areas is strictly prohibited.



**WARNING**

- Do not insert foreign objects into any part of the equipment.
- Set up standard warning signs and safety barriers near the equipment to prevent accidents caused by mis-operation or unauthorized access.



**CAUTION**

- Route all cables in designated positions. Exposed and irregular cable layout is susceptible to mechanical damage.

### NOTE

- Maintain a State of Charge (SOC) above 5% during use. Recharge within 48 hours after full discharge to avoid over-discharging.

## Maintenance Safety



**DANGER**

- Disassembling, modifying, or opening the battery is strictly prohibited.



**WARNING**

- Fully de-energize the battery unit before equipment relocation or any maintenance work.

- All battery terminals and circuit connectors must be disconnected before maintenance.
- Maintenance shall follow the sequence: equipment de-energization, lockout/tagout to prevent re-energization, zero-voltage verification, residual charge discharge and equipment grounding, and insulation shielding of adjacent live parts.
- Failure to observe warnings, improper installation, or operation by untrained personnel will lead to potential safety hazards.

#### **NOTE**

- Do not paint any internal or external components of equipment.
- Do not clean batteries with cleaning solvents.
- The battery storage system should be commissioned no later than six months after delivery.

### **Environmental Safety**



#### **DANGER**

- Open flames, sparks, and other ignition sources must be kept away from the system at all times.
- Damaged or failed batteries may leak electrolyte and produce hazardous substances such as hydrofluoric acid, which may cause severe chemical burns.



#### **WARNING**

- Do not expose the battery to flammable substances, corrosive chemicals, or their vapors.
- Do not submerge the battery in water or expose it to excessive moisture. The ingress protection rating of the equipment is only valid for fully assembled and intact configuration.
- If a battery is damaged or leaking, avoid direct contact with the substance. Contact technical support or a qualified recycling facility immediately for proper handling.

#### **NOTE**

- Where this manual does not cover a specific scenario, applicable safety regulations and occupational health standards shall prevail.
- You are obliged to handle waste batteries in compliance with applicable regulations, including removing any personal data from associated devices, and to return them to a designated or authorized recovery point. Used batteries must never be disposed of as household waste.
- Batteries contain important recyclable raw materials such as iron and lithium.

# 2 Product Introduction

## 2.1 Product Overview

The Rechargeable Li-ion Battery Storage System mainly consists of lithium battery packs, a power distribution unit (PDU), thermal management system, and fire suppression system.

It plays a significant role in reducing electricity costs, ensuring power reliability, integrating renewable energy, and optimizing energy management.

The following tables lists the main difference in GE-F240 series (refer to **Chapter 9 Technical Specifications** for more details).

Model	Battery Packs	Nominal Energy (kWh)
GE-F176-BC-2-A3	11	176.84
GE-F208-BC-2-A3	13	208.99
GE-F240-BC-2-A3	15	241.15

## 2.2 Application Scenarios

The following illustration shows basic application of this battery storage system. A complete operational system may require these core components:

- Generator or Utility
- PV modules
- Hybrid inverters

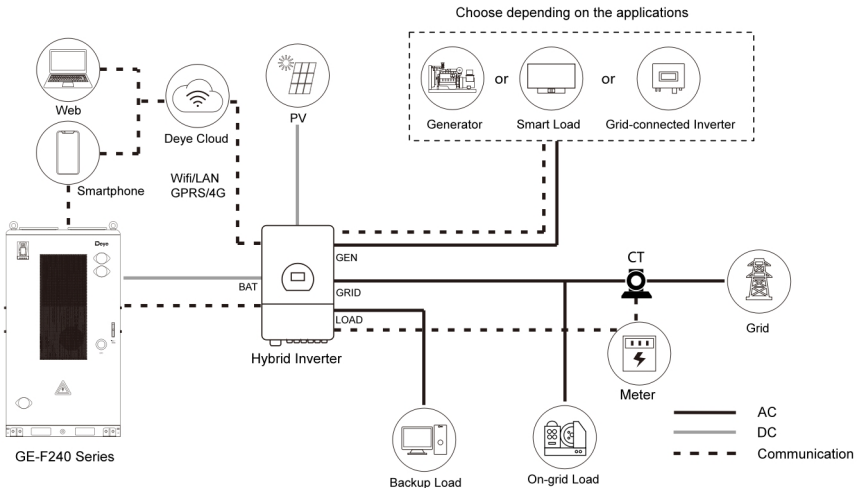

The system supports remote monitoring and control via Deye Cloud, accessible through

mobile devices (Bluetooth connection), web portals, or communication terminals on the inverter.

Consult with your system integrator for other possible system architectures depending on your requirements.

## 2.3 Product Appearance

### Front View

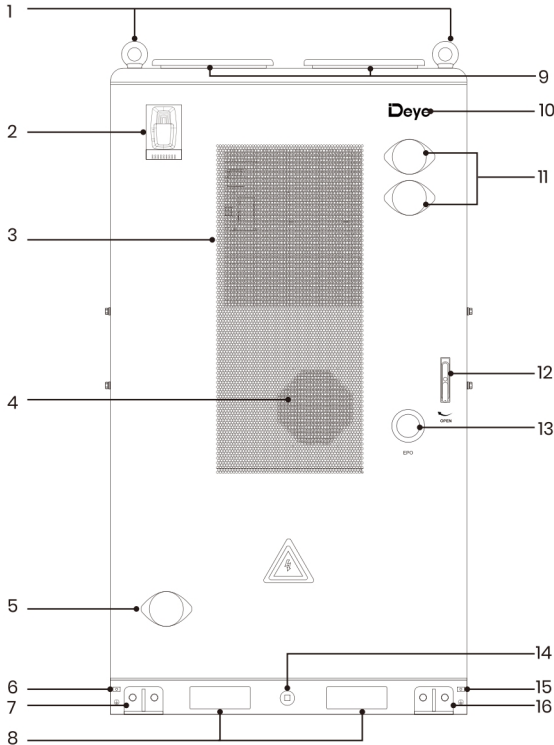

No.	Item	No.	Item
1	Eye bolt	9	Explosion Venting Panel
2	Audible & Visual Alarm	10	Status Indicator*
3	Air Conditioner Air Outlet	11	Exhaust valve
4	Air Conditioner Air Inlet	12	Door Lock
5	Intake Valve	13	EPO (Emergency Power Off) Button
6	Protective Earth Terminal	14	Water Inlet
7	Cabinet Mounting Feet	15	Protective Earth Terminal
8	Forklift Fork Insertion Position	16	Cabinet Mounting Feet

**\*Status Indicator:** The status indicator displays the equipment operating status by illuminating the Deye logo with different colors.

Color	Description
Blue	The system is in standby or discharge mode.
Green	The system is in charge mode.
Yellow	An alarm has been triggered.
Red	A fault has been detected and the system enters the protection mode.

**Side View**

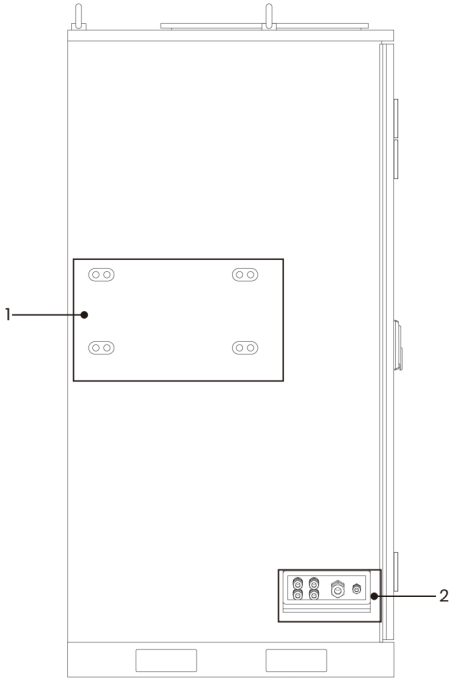

No.	Item	No.	Item
1	Inverter Assembly Holes	2	Cable Inlet

**Top View**

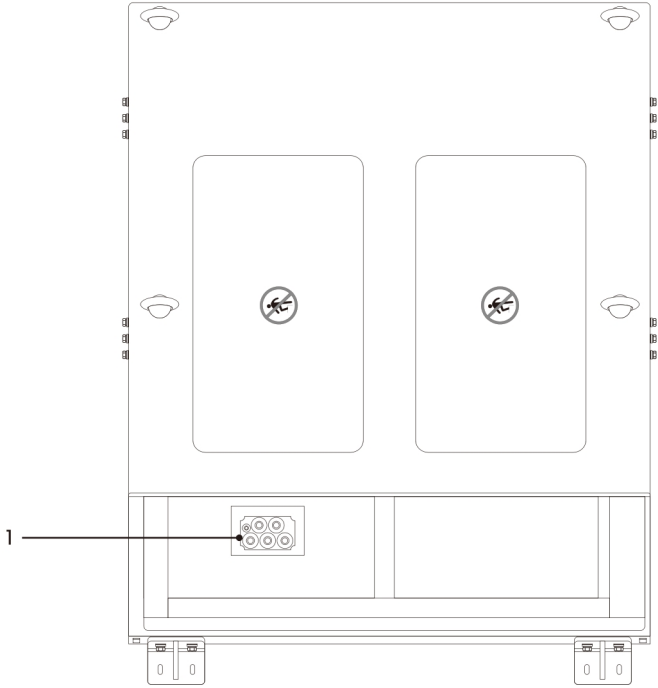

<b>No.</b>	<b>Item</b>
1	Cable Inlet

## 2.4 Internal Structure

### Internal Front View

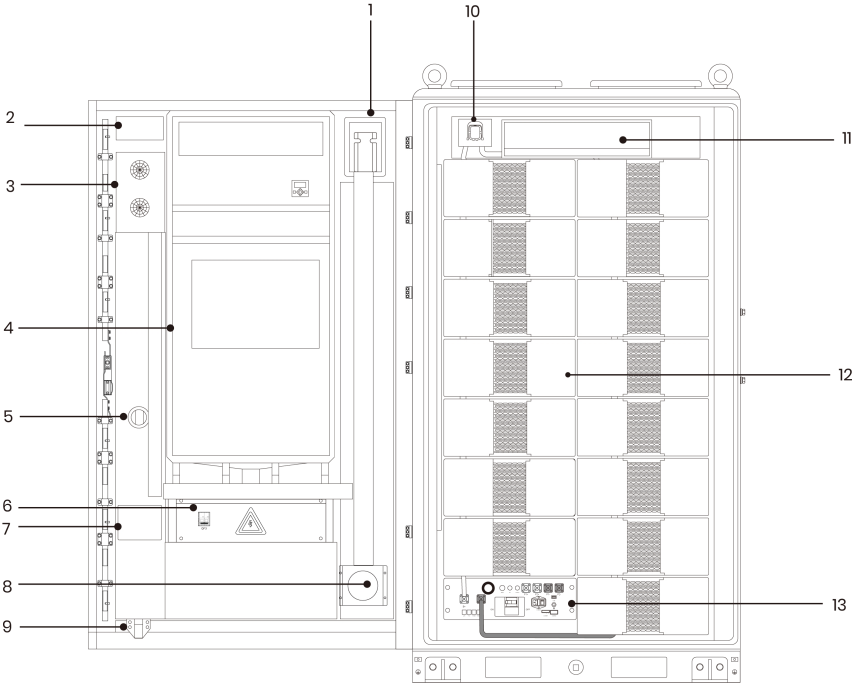

No.	Item	No.	Item
1	Audible & Visual Alarm	8	Intake Valve
2	Status Indicator Panel	9	Door Lifting Roller
3	Exhaust Valve	10	MSD (Manual Service Disconnect)
4	Air Conditioner	11	Circulation Air Intake Port
5	EPO Button	12	Battery Pack*
6	UPS (Uninterruptible Power Supply)	13	PDU (Power Distribution Unit)
7	Nameplate		

\*GE-F240-BC-2-A3: 15 battery packs

GE-F208-BC-2-A3: 13 battery packs

GE-F176-BC-2-A3: 11 battery packs

**Internal Left Side View**

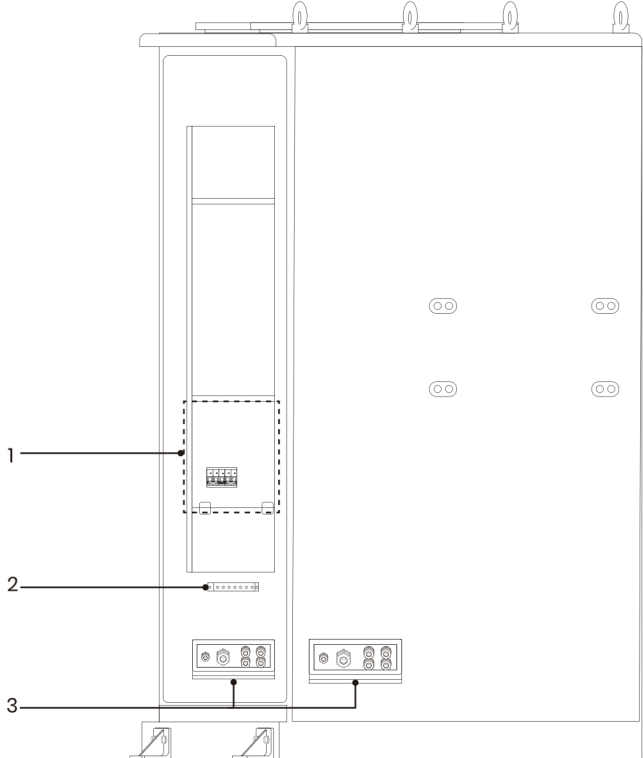

No.	Item	No.	Item
1	Terminal & Interface Control Area	3	Cable Inlet
2	Ground Busbar		

## 2.4.1 Battery Pack

■ **Charging Mode:** AC power from the grid or other power sources is converted to DC power by the inverter, which is then stored in the battery.

■ **Discharging Mode:** DC power discharged from the batteries is converted to AC power by the inverter, which is then supplied to connected loads.

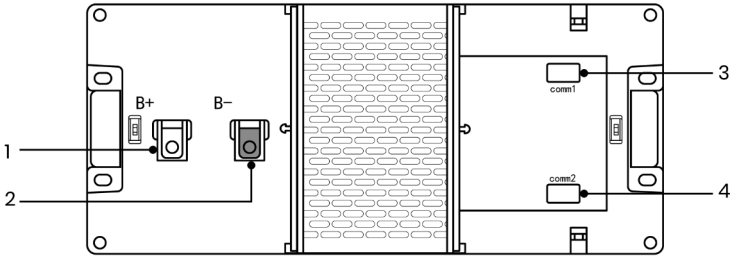

No.	Item	Description
1	B+	Battery module positive terminal (Orange)
2	B-	Battery module negative terminal (Black)
3	COMM1	Battery module communication and power supply input/output interface
4	COMM2	Battery module communication and power supply input/output interface

## 2.4.2 PDU

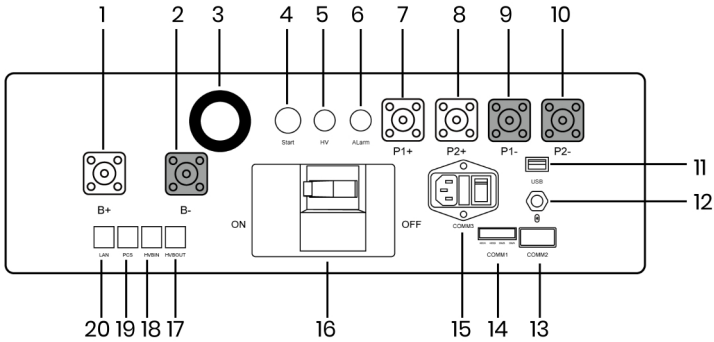

No.	Item	Description
1	B+	Battery module positive terminal (Orange)
2	B-	Battery module positive terminal (Black)
3	Display Screen	Displays system SOC values and fault codes.
4	Start Button	12 VDC internal power start switch for the PDU
5	HV indicator	High-voltage hazard indicator (Yellow)
6	Alarm indicator	Battery system alarm indicator (Red)
7	PCS1+	Terminal for the first PCS positive connection (Orange)
8	PCS2+	Terminal for the second PCS positive connection (Orange)
9	PCS1-	Terminal for the first PCS negative connection (Black)
10	PCS2-	Terminal for the second PCS negative connection (Black)
11	USB	BMS upgrade port and storage expansion port
12	Bluetooth	Wireless connection port for mobile APP
13	COMM2	Communication port for the first battery module; provides 12 VDC power supply to the first battery module
14	COMM1	RS485 communication interface & emergency power-off trigger interface
15	COMM3	This port must be connected to a power supply: 200~240 VAC, 50/60 Hz, 3 A; otherwise, the fan cannot operate normally. Internal fuse specification: 230 Vac, 10 A; dimensions: 20*5 mm
16	DC circuit breaker	Manual switch for connecting / disconnecting the battery rack and external devices.

17	OUT COM	Communication output port for connection with the next BOS-B-PDU-2-A communication input.
18	IN COM	Communication input port for connection with the previous BOS-B-PDU-2-A communication output.
19	PCS COM	PCS battery communication terminal; used to transmit battery data to the inverter.
20	Ethernet	Standard RJ45 Ethernet port. Customizable for different needs.

**Display Screen**



For the detailed fault codes, refer to **Appendix I Troubleshooting**.

### 2.4.3 Air Conditioner

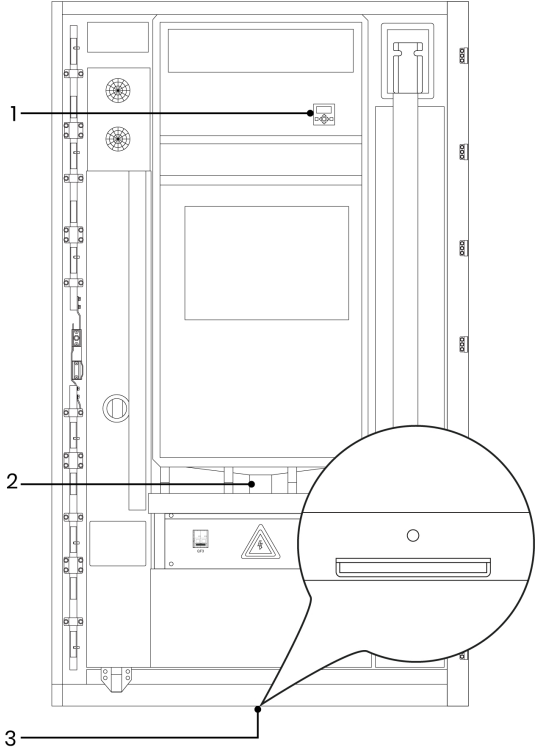

No.	Item	No.	Item
1	Air Conditioner Control Panel	3	Condensate Drain Outlet
2	Condensate Drain Pipe		

## 2.4.4 Fire Suppression System

### Internal Right Side View

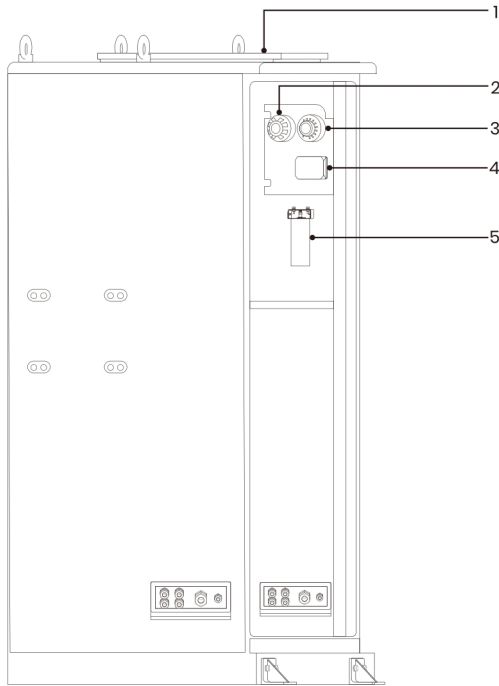

No.	Item	Description
1	Explosion Venting Panel	Two explosion venting panels are located at the top of the cabinet. In case of an explosion, these panels respond to the shock waves generated by pressure differentials, opening efficiently to reduce the impact on internal components.
2	Smoke Detector	Adopts the light scattering principle to sense smoke, sensitive to slow-burning, smoldering fires and equipped with a red LED alarm indicator. Selected models feature a flashing LED and magnet-operated test switch.
3	Heat Detector	Monitors temperature using a dual - thermistor network (one exposed, one insulated) to provide a voltage output proportional to ambient temperature. It emits a red light when an abnormality is detected and supports a wide operating voltage range.

4	CO Detector	Measures concentrations of carbon monoxide and combustible gases. It supports RS485 and alarm point output.
5	Aerosol	The aerosol fire suppression unit is triggered by electric signal or open flame. The aerosol generator is activated to decompose the chemical coolant to produce a fire - suppressing aerosol.

**Water-based Fire Suppression System**



**DANGER**

- In case of severe fire, evacuate immediately and call the fire department.



**CAUTION**

- For safety, the manual master valve on the fire-fighting water pipe should extend at least 3 meters horizontally from the foundation.
- The final layout of fire protection equipment is subject to review and approval by the local Authority Having Jurisdiction (AHJ).

This water-based fire suppression system serves as the final protective barrier for the energy storage system (ESS). It can be activated manually according to on-site requirements.

Extension pipes (provided by the customer) should be installed through the cabinet’s DN40 water inlet. A manual master valve shall be installed on this pipe, positioned at least 3 m away from the cabinet, to serve as the primary manual activation for the entire water supply. For multiple cabinets, a separate control valve shall be installed on the branch pipe to each individual cabinet.

It is recommended that the inlet pressure of the water connection port be not less than 0.16 MPa and the inlet flow rate be not less than 10 L/s.

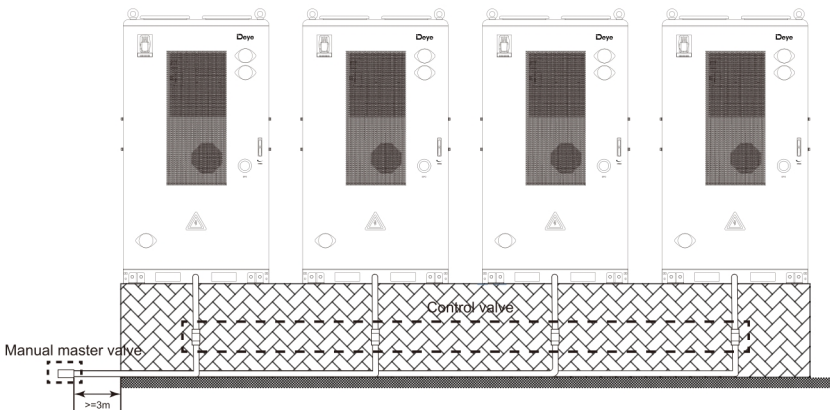

## 3 Transportation

### 3.1 Safety Precautions



#### **DANGER**

- Transportation of end-of-life, damaged or recalled batteries may be prohibited in some regions. Confirm local regulations before transportation; illegal transportation is strictly prohibited.
- It is strictly prohibited to mix dangerous goods with food, medicine, animal feed and their additives in the same vehicle or container, and to transport with sharp objects in the same vehicle or container.



#### **WARNING**

- Lithium-ion batteries are classified as UN3480, Class 9 Miscellaneous Dangerous Goods. For sea, land and air transportation, they fall under PI965 Section I. Class 9 dangerous goods labels and UN identification labels must be affixed during transportation.
- Transportation and storage service providers must hold the dangerous goods operation certification required by local laws and standards; no relevant business shall be undertaken without corresponding qualifications.
- Sea transportation shall comply with the requirements of the International Maritime Dangerous Goods Code (IMDG Code), and land transportation shall meet ADR or JT/T 617 transport standards; illegal selection of transport modes is strictly prohibited.
- If the battery has peculiar smell, leakage, smoke, fire or any other abnormalities before transportation, transportation is strictly prohibited.
- Obtain MSDS certification before sea transportation, seal the external gaps of containers and affix marks certified by the classification society; equip the outer packaging with rainproof canvas covers to avoid paint film scratches.
- Remove obstacles along the transport route, confirm that transport vehicles/containers meet dangerous goods transport standards, and ensure dangerous goods transport vehicles are equipped with two tested CO<sub>2</sub> fire extinguishers.
- Before removing the transport protector, check whether the packaging is damaged and whether the impact indicator on the outer packaging of the battery converter is triggered; if triggered, the risk of transport damage cannot be ruled out.
- When transporting faulty batteries, avoid flammable and explosive material

storage areas, residential areas, mass transit facilities, elevators and other densely populated places.

- Only the top lifting lugs of the battery cabinet are allowed for lifting, and the included angle of slings shall be at least 60°; illegal lifting is strictly prohibited.
- Battery cabinets must be fixed vertically; transport vehicles with twist locks are recommended. If twist locks are unavailable, the product shall be fixed at both the top and bottom with lashing straps to prevent displacement and rollover during transportation.
- No speeding for land transportation: speed limit of 70km/h on highways, 40km/h on town roads, 50km/h when turning; sudden start and emergency braking are strictly prohibited.
- Keep containers upright during the whole sea transportation, ensure the packing cases are firm and reliable during loading and unloading, take moisture-proof measures, and operate smoothly throughout the process.



#### **CAUTION**

- During the whole transportation process, strictly prevent severe vibration, impact and extrusion, avoid direct sunlight, rain and moisture, and take rainproof, moisture-proof and sun-protection measures.
- Prefer sea or land transportation with good road conditions; if transportation on a slope is required, additional traction devices shall be added. The inclination angle of equipment shall not exceed 15° during the whole transportation.
- Smoking is strictly prohibited in transportation, loading and unloading areas. Freight personnel are not allowed to open the outer packaging of battery packs without permission; handle with care during moving to prevent bumping.
- Transport operators must wear protective gloves and toe-cap safety shoes for personal protection, and pay special attention to avoiding scratches by sharp metal panels and crushing injuries by heavy objects.

#### **NOTE**

- All operations must be completed by professionally trained personnel, and unauthorized operation by non-professionals is strictly prohibited.
- Complete compliant and accurate declaration before transportation, and carefully check whether the battery packaging, labels and markings are intact.
- Transport vehicles/containers must meet dangerous goods transport standards to ensure the product is firmly fixed throughout the transportation process.
- Do not remove the product transport packaging before arrival at the installation site; remove it after arrival.

## 3.2 Transportation Methods

### 3.2.1 Forklift



 **DANGER**

- During forklift operation, unrelated personnel must keep at least a 2m safe distance; standing or riding on the forklift or cargo is strictly prohibited.
- Overloading and lifting loads too high are strictly prohibited to avoid forklift instability and rollover risks.
- Only certified professional forklift operators may perform operations; unauthorized operation by non-professionals is forbidden. Strictly follow all clauses; violators bear full responsibility for equipment damage and personal accidents.

**NOTE**

- The rated bearing capacity of the forklift shall be more than 5 t.

**Fork Positioning & Loading:**

Insert forks strictly into the designated "Forklift Fork Insertion" mark (   ) on the packaging. When lifting heavy or unbalanced loads, align with the center of gravity mark (  ) to ensure balance.

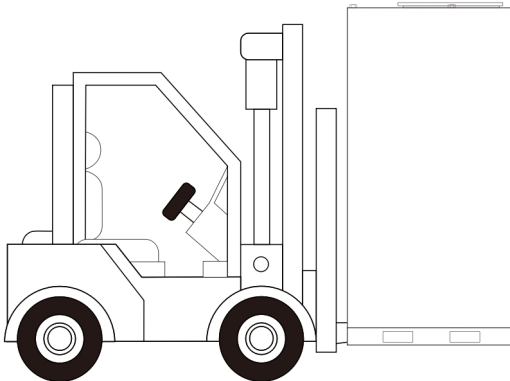

**Driving & Steering:**

- Driving speed shall be strictly controlled below 3 miles per hour (3mph). Sharp turns are strictly prohibited to avoid cargo shaking and imbalance.
- Before reversing, the forklift operator must carefully check the rear area and confirm safety before reversing. When reversing in confined spaces, a special commander

must be arranged to guide the operator throughout the process.

- Operating forklifts on slopes with a gradient  $\geq 5^\circ$  is strictly prohibited. Slow down and operate carefully when lifting loads on uneven roads.
- Tilting or inverting the cabinet is strictly prohibited during the whole transfer process. If tilting or inversion is necessary under special circumstances, restore the cabinet to upright position as soon as possible, and leave it standing for 2 hours before power-on.

### 3.2.2 Hoisting

#### DANGER

- Do not stand within 0.5-1m of the lifting area. No one is allowed to stand under the boom and operation station during the whole hoisting process.

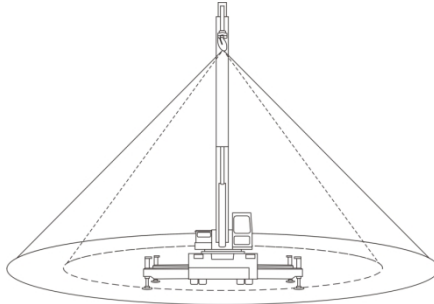

- It is forbidden to conduct hoisting operations in bad weather such as typhoon, heavy rain, thick fog and thunderstorm.
- Ensure correct and firm connection between equipment and lifting tools before hoisting. Non-standard connection may cause product damage, serious injury or even death.
- Do not lift or move the energy storage system equipment after batteries are installed.
- Only use approved and certified lifting equipment to move the product, and non-standard lifting tools are strictly prohibited.
- Only qualified personnel can hoist the equipment.

#### WARNING

- Before hoisting, check the crane, hoisting ropes and other equipment to confirm their load parameters meet the bearing requirements of the product.
- Ensure all doors of the equipment are closed and locked before hoisting to keep the cabinet airtight and loose-free.
- Ensure the crane is placed at a suitable position, and long-distance hoisting is

strictly prohibited.

- Ensure all sling connections are safe and reliable, and the lengths of slings connected to cabinet corner fittings are equal.
- A professional commander is required throughout the entire hoisting process to uniformly schedule the operation.
- Keep the equipment stable and non-skewed during hoisting. It is forbidden to shake the crane to avoid sudden drop or impact on the equipment.



**CAUTION**

- The length of slings can be adjusted appropriately according to actual requirements of the installation site to ensure hoisting balance.
- Handle hoisting gently, lower the cabinet slowly and smoothly to the position, and eliminate impact and collision.
- Adopt vertical hoisting, and do not drag the cabinet on any surface during hoisting. Do not drag the cabinet when assembling or disassembling lifting tools to prevent scratches on the cabinet surface.
- It is recommended to hoist the equipment smoothly along the left-right horizontal direction to ensure stable operation.

Before hoisting the product, follow the steps below to install the eyebolts.

1. Take 4 eye bolts from the accessory kit (refer to section **4.2 Packing List**).
2. Remove the four pre-installed M30\*40 screws.

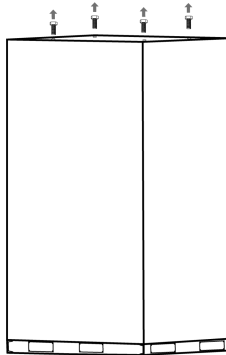

3. Insert eye bolts into the holes and rotate the them clockwise until they are firmly secured.

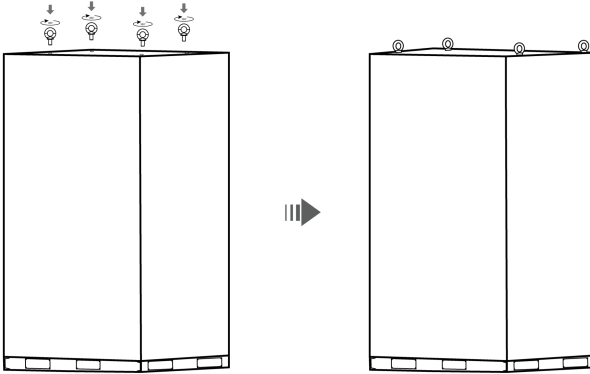

During hoisting, make sure that the horizontal angle between the lifting sling and the equipment is maintained between  $45^{\circ}$  and  $60^{\circ}$ .

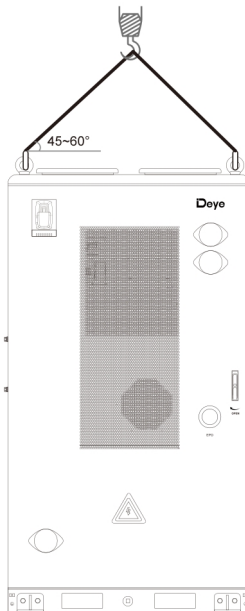

# 4 Installation



## DANGER

- Do not expose the equipment to flammable or explosive gases, smoke, or any explosive environments, and do not operate the equipment in such environments. Otherwise, it may cause serious safety accidents such as fire, explosion, or equipment damage.
- There is a risk of static overload during the entire installation process, which may cause damage to building structures. Be sure to verify the site bearing capacity and anti-static measures in advance.



## CAUTION

- Only qualified or trained personnel, who have mastered all necessary safety precautions and relevant applicable regulations, are permitted to install the equipment.
- Keep the equipment out of the reach of children and away from daily working or living areas.



## WARNING

- The installation and usage environment must comply with relevant international and local laws and regulations. The user is obligated to protect the ESS against fire and other hazards.
- Product assembly must be carried out in strict accordance with the design scheme, process requirements, relevant regulations and national standards; unauthorized changes to assembly procedures and technical parameters are strictly prohibited.

## 4.1 Pre-Installation Preparation

### 4.1.1 Site Requirements



## DANGER

- Do not install the equipment in low-lying areas where it may become submerged. The installation level must be at least 300 mm above the highest historical water level in the area. Do not install in any position that could be submerged in water.



## WARNING

- Install the equipment in an outdoor area far from liquids. Do not install it under

areas prone to condensation (e.g., under water pipes, air exhaust vents) or water leakage (e.g., air conditioner vents, ventilation vents, equipment room feeder windows). Liquid ingress may cause equipment faults, short circuits, fires, or electric shock.

- To prevent high-temperature damage or fire, ensure that the equipment's ventilation vents and heat dissipation systems are not obstructed or covered by other objects during operation. Poor heat dissipation can lead to equipment overheating, fire, or explosion.
- To protect the equipment from wildfires caused by high summer temperatures, ensure there are no vegetation or flammable plants within 3 meters of the equipment. Wildfires can spread to the equipment, causing explosions or fires.
- For safety purposes, the distance between the equipment and residential buildings must be more than 12m, and the distance between the equipment and densely populated buildings (such as schools, hospitals) must be more than 30.5m. If this safety distance cannot be met, a firewall must be built between the equipment and the building to prevent fire or explosion hazards from affecting people.
- Outdoor storage systems must be at least 10 feet away from boundaries, public roads, buildings, flammable materials, hazardous materials, high piles, and other non-grid-related hazards to reduce the risk of fire, explosion, or collision-induced accidents.
- The distance between the energy storage system's exhaust device and the air intakes of heating, ventilation, and air conditioning systems, windows, doors, discharge platforms, and fire sources of other buildings or facilities must be more than 4.6m to prevent the spread of harmful gases or fire.
- Do not install the equipment in places without proper fire-fighting facilities or where firefighters cannot easily access. In the event of a fire, lack of fire protection or accessibility will lead to the rapid spread of fire, resulting in serious injury or death.
- Do not install the equipment in an easily accessible location. The enclosure and heat sink of the ESS reach high temperatures during operation, which may cause severe burns.
- Do not install the ESS on moving objects (such as ships, trains, or cars). Vibration and instability during movement may damage the equipment, leading to leaks, fires, or explosions.
- Do not install the equipment in environments with magnetic dust, volatile or corrosive gases, infrared or other radiation, organic solvents, conductive metals, or salty air. These environments can corrode or damage the equipment, leading to short circuits, fires, or explosions.

- Do not install the equipment near areas that may produce interfering or harmful gases (such as garbage dumps or chimney outlets). These gases may corrode the equipment or create an explosive atmosphere.
- Do not install the equipment in areas with strong vibration, noise, or electromagnetic interference. These factors can damage the equipment's internal components, leading to malfunctions, fires, or explosions.
- During the installation, commissioning, and operation of the energy storage system, ensure that each unit is equipped with no less than 2 fire extinguishers nearby. Insufficient fire-fighting equipment may result in uncontrollable fires, leading to death or serious injury.

 **CAUTION**

- Do not install the equipment in areas conducive to the growth of microorganisms (such as fungi or mildew). Microbial growth may damage the equipment's surface or internal components, leading to malfunctions and potential minor injuries during maintenance.
- Do not install energy storage systems in salt-damaged or polluted areas. Corrosion caused by these environments may damage the equipment, leading to malfunctions and minor injuries during handling or maintenance.

The battery storage system must be installed in locations that meet the following criteria:

Condition	Required Distance	Examples
Distance from coast	More than 2000 m	/
Distance from pollution sources	Heavy pollution sources: ≥1500 m	Smelters, coal mines, thermal power plants
	Moderate pollution sources: ≥1000 m	Chemical, rubber, electroplating
	Mild pollution sources: ≥500 m	Food, leather, heating boilers, slaughter houses, centralized garbage dumps, sewage treatment stations

**NOTE**

- The pollution degree inside the cabinet is PD2 and PD3 for outside the cabinet.
- The safe distance between the equipment and production buildings shall comply with local fire codes or standards.
- Install the equipment in a clean, dry, and well-ventilated area with appropriate temperature, humidity, and altitude. For detailed parameters, refer to the **Technical Specifications** section.

- Reserve sufficient space for expansion according to the whole-life cycle needs of the energy storage system.

**Recommended Clearance**

The following clearance should be reserved before installing multiple systems.

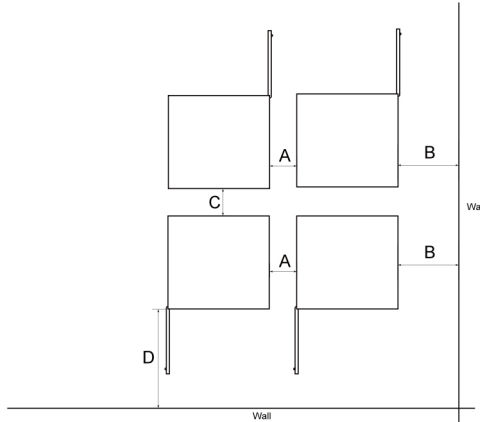

No.	Distance (mm)	No.	Distance (mm)
A	100	C	100
B	100	D	1500

**4.1.2 Foundation Requirements**

An inadequately designed foundation can cause installation difficulties, compromise cabinet door operation, and undermine overall system performance. Therefore, the foundation for the Energy Storage System (ESS) must be carefully designed and constructed in strict compliance with applicable industry and local standards to ensure proper mechanical support, cable routing, and future maintenance access.

At a minimum, the following requirements shall be met.

Requirement	Description
<b>General Requirements</b>	
Surface material	Install cabinets on concrete or other non - combustible surfaces.
Surface condition	The surface must be level, stable, flat, and free of depressions or tilts, with sufficient load-bearing capacity.
Load capacity	The foundation must support the total weight of the equipment. If the bearing capacity is insufficient, re - verification is required.
Extension beyond	100 mm on each side

cabinet	
<b>Foundation Construction Requirements</b>	
Concrete grade & thickness	Default C30 with a thickness of 200mm, unless otherwise specified
Bedding layer	100 mm thick C15 concrete below the slab
Reinforcing steel bars	HRB400 (Grade III), 12 mm diameter, spaced 150 mm apart
Corrosion protection	Apply standard anti - corrosion measures to steel bars after rust removal.
Bearing stratum	Undisturbed soil with characteristic bearing capacity $\geq 100$ kPa.
<b>Construction &amp; Excavation Requirements</b>	
Foundation pit compaction	The bottom of the pit must be compacted and leveled before construction.
Construction dewatering	Implement dewatering to prevent waterlogging in the pit.
Excavation safety	Ensure proper safety measures for excavation support.
Water prevention after excavation	The pit must not be soaked. If water intrusion occurs, further excavation and replacement filling are required.
Surface leveling tolerance	Levelness error between foundation and cabinet contact surface $\leq 3$ mm.
<b>Height &amp; Drainage Requirements</b>	
Height above ground	Foundation must be higher than the local historical highest water level, and at least 300 mm above the surrounding ground level.
Drainage system	Drainage facilities should be based on local geology and municipal requirements to prevent water accumulation at the foundation. The system must accommodate the local historical maximum rainfall. Discharged water must comply with local environmental regulations.
<b>Cable Management &amp; Sealing</b>	
Cable outlets/ trenches	Foundation design shall accommodate ESS cable outlet positions, with pre-reserved trenches or entry holes as required.
Sealing	All reserved foundation holes and equipment bottom inlet ports shall be fully sealed post-installation.

For ESS cabinets with bottom cable entry (no side cable inlets are provided to prevent

foreign material ingress), on-site cable trenches must be pre-installed in compliance with the following requirements:



<b>Cable Trench Requirements (for bottom cable entry)</b>	
<b>Requirement</b>	<b>Description</b>
Dust & Rodent Protection	Prevent foreign objects from entering the cabinets.
Waterproof & Moisture Protection	Protect cables from aging and short circuits that could affect normal operation.
Cable bending radius	Account for large cable cross - sections (due to high power rating) and provide adequate bending radius.

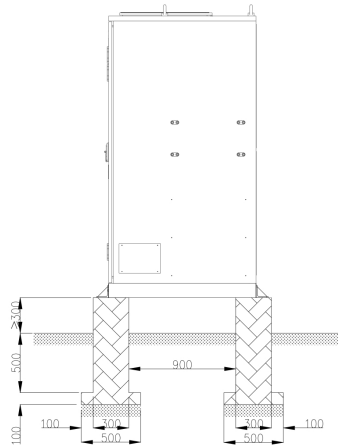





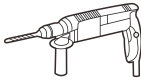

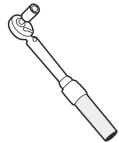
The recommended foundation construction details are provided below and may be adjusted based on actual site conditions.

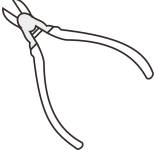
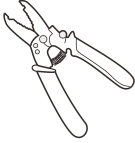
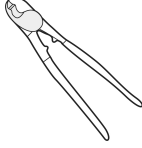
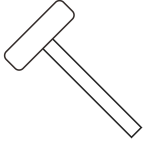
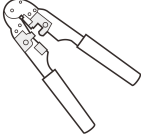
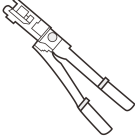



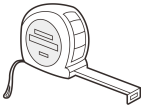
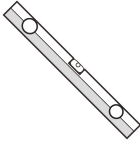
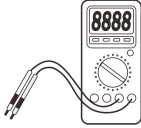
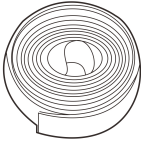
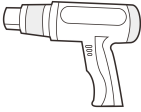
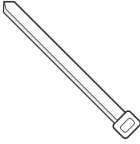



### 4.1.3 Tool Requirements

Recommended installation tools and personal protective equipment are listed below and the pictures are for reference only.

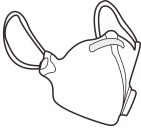
<b>Tools</b>			
			
Hammer drill	Phillips insulated torque screwdriver	Flat-head insulated torque screwdriver	Insulated torque socket wrench

			
Diagonal pliers	Wire stripper	Cable cutter	Rubber mallet
			
RJ45 crimping tool	Hydraulic pliers	Needle-nose pliers	Marker
			
Utility knife	Steel tape measure	Spirit level	Multimeter
			
Heat shrink tubing	Heat gun	Cable tie	Insulated ladder
			
Forklift	Crane		

Personal Protective Equipment			
			
Insulated gloves	Protective gloves	Safety goggles	Dust mask
			
Insulated shoes	Safety helmet	Protective suit	

## 4.2 Packing List



### WARNING

- If the installation environment is not conducive to equipment protection, take measures to prevent internal battery failure caused by condensation or dust corrosion (e.g., cover with woven cloth or dust cover).
- During component handling and storage, collision and scratch are strictly prohibited. Keep parts dry and rust-free to avoid damage and part failure.



### CAUTION

- If possible, do not remove the transport packaging until the equipment arrives at the installation site.
- After preparing the equipment for installation, unpack it carefully to avoid scratching the equipment.
- Keep the equipment stable during unpacking.

### NOTE

- Unpack and inspect the equipment immediately upon receipt. If the unit is damaged or missing accessories are found, contact the local distributor or the after-sales service department.
- All components must be thoroughly cleaned before assembly to remove burrs, flash edges, oxide layers, rust, sand particles, dust and stains, ensuring a clean and impurity-free surface.

The accessory kit for battery cabinets includes standard parts and inverter-specific parts for connection with different inverter/PCS models.







### Accessory Kit:

- **GE-F256-AP-A:** Packing List 1 + Packing List 2
- **GE-F256-AP-C:** Packing List 1 + Packing List 3

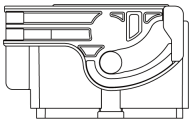
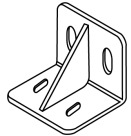
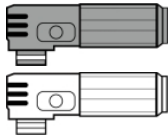

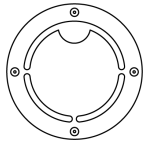
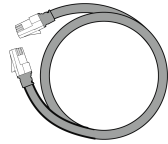

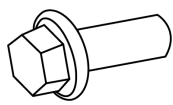
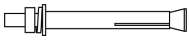
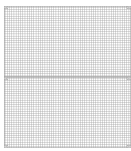
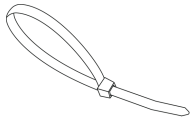
### NOTE



- GE-F256-AP-A is compatible with inverter models SUN-125K-SG02HP3-EU-GM10 series, SUN-80K-SG02HP3-EU-EM6 series, SUN-50K-SG01HP3-EU-BM4 series and SUN-50K-SG02HP3-EU-BM4 series, while GE-F256-AP-C is compatible with PCS SUN-125K-PCS01HP3+SUN MPPT-L01-EU-AM8+SUN-STS500L.

**Packing List 1**

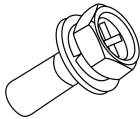
			
Manual service disconnect (MSD)×1 pc	Cabinet mounting feet ×4 pcs	Terminal Connector ×1 set	Terminal resistor ×1 pc
			
PMMA sheet ×1 pc (φ=113mm, t=2mm)	3000mm 26AWG communication cable ×1 pc (black)	Fire-proof mud ×1 bag (2.5kg)	M16*40 Hex bolt ×8 pcs (with spring washer and flat washer)
			
M12*80 Expansion bolt ×8 pcs	Insect screen ×2 pcs	Cable tie ×20 pcs	M30 Eye bolts×4 pcs

**Packing List 2**

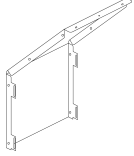
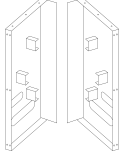
<p><b>For cabinet-mounted inverter models:</b>                  SUN-125K-SG02HP3-EU-GM10 series, SUN-80K-SG02HP3-EU-EM6 series,                  SUN-50K-SG01HP3-EU-BM4 series and SUN-50K-SG02HP3-EU-BM4 series                  (Referred to as 125kW Inverter, 80kW Inverter, 50kW-1 and 50kW-2 Inverter respectively)</p>			
			
3000mm 3AWG Negative power cable ×2 pcs (black)	3000mm 3AWG Positive power cable ×2 pcs (red)	M4*10 Hex bolt ×22 pcs	Inverter mounting bracket ×2 pcs

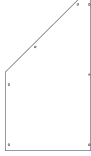
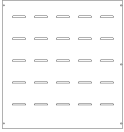
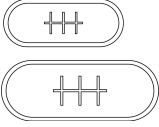
<b>Cable Cover *1 set, including:</b>			
			
Angled side bracket ×1 pc	Vertical mount plate ×1 set	Cable management rail ×3 pcs	Angled side panel ×1 pc
			
Front cover ×1 pc	Cable grommet × 2 sets		

### Packing List 3

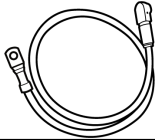
<b>For independent cabinet type PCS:</b>	
SUN-125K-PCS01HP3+SUN MPPT-L01-EU-AM8+SUN-ST500L	
	
3000mm 1AWG Negative Power Cable ×1 pc (Black)	3000mm 1AWG Positive Power Cable ×1 pc (Red)

### Recommended Torque

The following torque is applicable for sheet metal parts (battery cabinet assembly/bracket connection).

<b>Bolt Specification</b>	<b>Recommended Torque</b>	<b>Unit</b>
M3	0.7 ~ 0.9	N·m
M4	1.6 ~ 2.2	N·m
M5	3.2 ~ 4.4	N·m
M6	5.3 ~ 7.4	N·m
M8	12 ~ 19	N·m
M10	25 ~ 38	N·m
M12	44 ~ 65	N·m
M14	54 ~ 108	N·m

M16	110 ~ 165	N·m
M18	150 ~ 240	N·m
M20	216 ~ 335	N·m

**NOTE**

- Strictly adhere to the specified torque values to prevent over-tightening or under-tightening.
- The torque value is for reference only for standard bolts during normal assembly; adjust appropriately for special working conditions (high vibration/harsh environment).
- Use a calibrated torque wrench for installation to ensure torque accuracy.

### 4.3 Installation Procedures

#### 4.3.1 Install Cabinet Mounting Feet

**NOTE**

- Due to variations in drilling accuracy and bit material, it is recommended to use a drill bit with a diameter ranging from  $\phi 20.5$  to  $\phi 21$ .

To secure the cabinet to the ground, install the four cabinet mounting feet. Two installation methods are available: front-rear mounting and left-right mounting, which are identical in the installation steps while mounting positions differ.

The following instructions use the front-rear mounting method as an example.

1. Position the cabinet at the installation site.
2. Align the mounting feet to cabinet holes. Do not tighten the screws.
3. Mark hole positions on the ground.
4. Remove the mounting feet and drill holes (102–105 mm deep) with a hammer drill, and pre-install 8 pieces of M12×80 expansion bolts with a torque of 140 N·m.

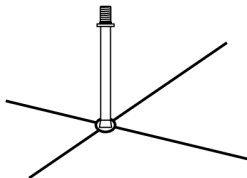

5. Secure the mounting feet to the cabinet with M16×40 hex bolts.

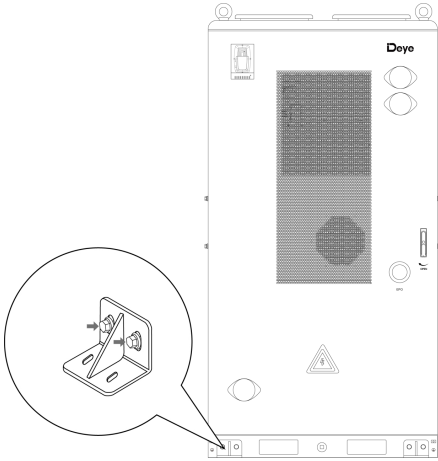

6. Install expansion bolt nuts to mount the cabinet to the ground.

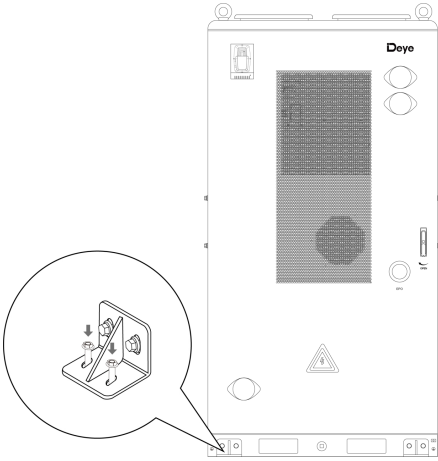

### 4.3.2 Install the Insect Screen

**NOTE**

- It is recommended to install an insect screen in environments prone to airborne debris such as catkins, large insects and other foreign particles, to preserve efficient heat dissipation and ensure stable operation.

Align the insect screen with the air inlet/outlet area of the cabinet air conditioner. Press it firmly into place and the magnetic strips on both sides of the screen will secure it to the equipment.

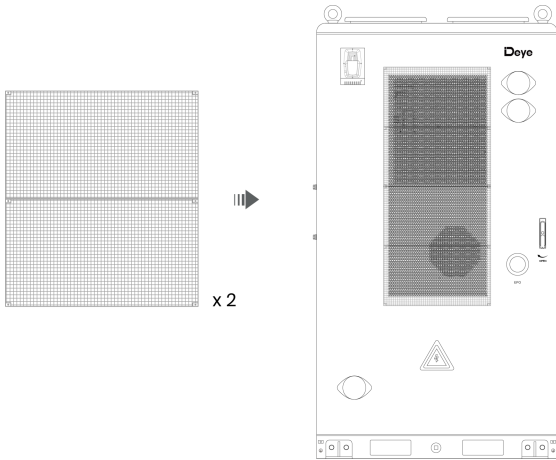

### 4.3.3 Install the Inverter

#### Mounting Bracket Preparation

Prepare the following mounting brackets before installation.

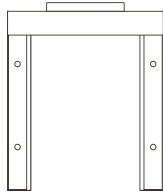
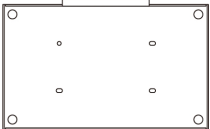
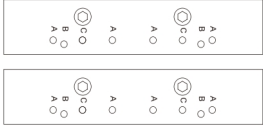
	<p>Wall bracket 1 Included in the accessory kit of 125kW/80kW/50kW-1 inverters</p>
	<p>Wall bracket 2 Included in Inverter accessory kit of 50kW-2 inverter</p>
	<p>Inverter mounting bracket Included in the cabinet accessory kit</p>

#### Lifting Method Selection

Select the appropriate method for mounting the inverter onto the cabinet based on the inverter model and site conditions.

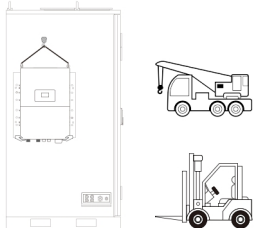
Method	Description	Recommended For
<p><b>Method A</b> <b>Crane/Forklift</b></p>	<p>Hoist the inverter using a crane or forklift. Suitable when heavy lifting equipment access is available.</p> 	<p>125 kW inverters</p>
<p><b>Method B</b> <b>Fixture + Chain Hoist</b></p>	<p>Use the dedicated lifting fixture with a hand chain hoist. Suitable for space-constrained sites.</p>	<p>125 kW inverters</p>

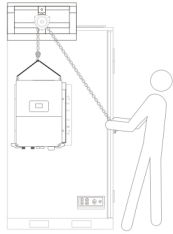
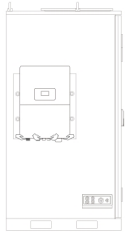
		
<p><b>Method C</b> <b>Manual Handling</b></p>	<p>Lift the inverter manually.</p> 	<p>50 kW/ 80 kW inverters</p>

**Installation Steps**

The compatible inverter can be mounted on either the left or right side of the cabinet based on site requirements. The following installation procedures take the left-side mounting configuration as an example for illustration.

Follow the steps below to install inverters of different models.

**Installation steps for 125 kW inverter**

1. Prior to inverter installation, remove the factory-fitted fixing screws on the left side of the cabinet. Keep these screws properly for later installation.
2. Align the **larger holes** on each inverter mounting bracket with the **innermost inverter assembly holes** on the cabinet.

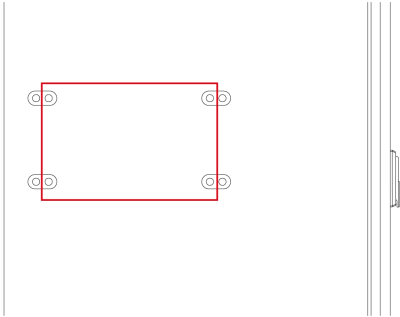

3. Ensure the larger holes on both brackets face inward. Fasten the two inverter

mounting brackets to the cabinet using the factory-fitted screws.

- Using factory-fitted fixing screws, fasten the wall bracket to the screw holes marked **B** on the pre-installed inverter brackets.

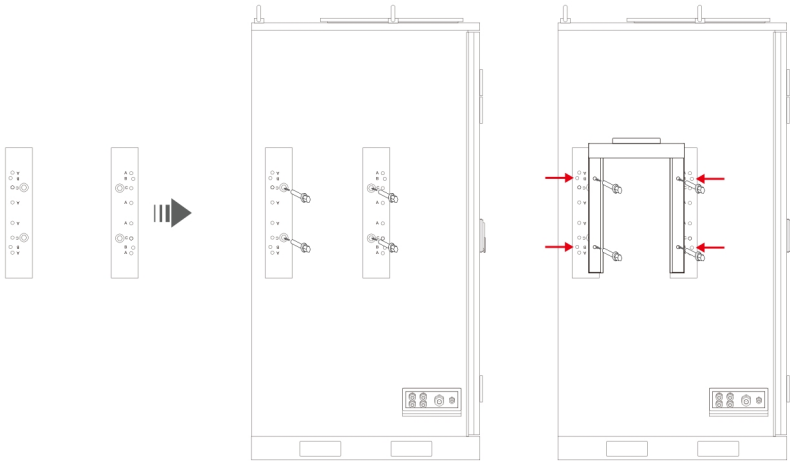

- After the wall bracket is securely mounted as instructed, proceed to lift and install the inverter. Two lifting methods are available for 125kW models:

**⚠ WARNING**

- Ensure proper fall protection measures are in place throughout the lifting operation.

**Option A:** Use a crane, forklift or other suitable hoisting equipment.

If such lifting equipment is available on site, lift the inverter steadily and slowly and guide it carefully onto the pre-installed wall bracket. Proceed directly to **Step 6**.

**Option B:** Use the dedicated lifting fixture shown below (optional, available via your local distributor or official after-sales service)

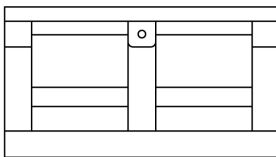

Front view

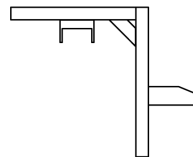

Side view

- Remove the eyebolts from the top of the cabinet. Align the mounting holes of the lifting fixture with the threaded holes on the cabinet top, and secure the fixture to the cabinet by reinstalling the eyebolts.

- b.** Pass a chain hoist through the fixture's bolt and lock it with a nut. Attach the hoist hook to the eyebolts on the inverter. Lift the inverter steadily and slowly and position it onto the pre-installed wall bracket.
- Once the inverter is securely installed, remove the fixture and reinstall the eyebolts to the cabinet top.

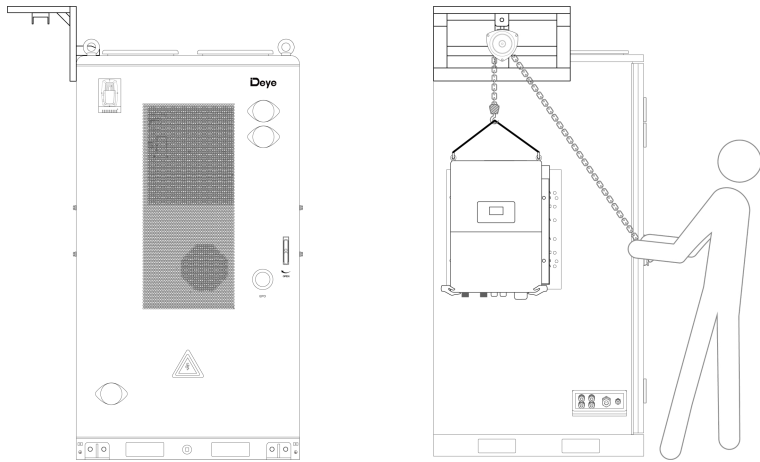

6. Secure the inverter to the bracket using the screws supplied with inverter: 3 screws per side, 6 screws in total.

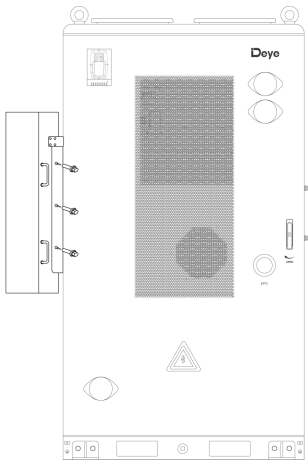

## Installation steps for 80 kW inverter

1. Prior to inverter installation, remove the factory-fitted fixing screws on the left side of the cabinet. Keep these screws properly for later installation.
2. Align the holes on the wall bracket with the **innermost inverter assembly holes** on the cabinet.

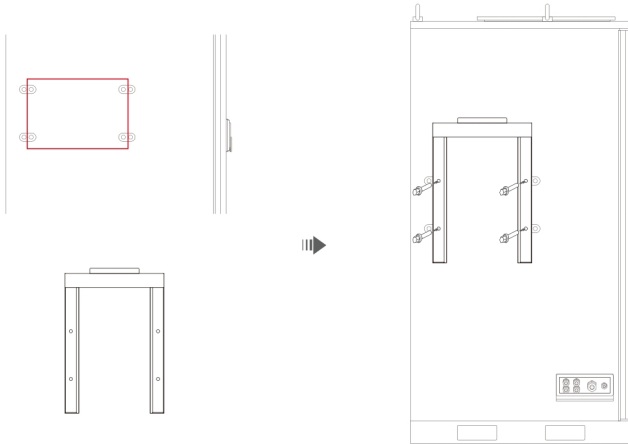

3. After the wall-mount bracket is securely fastened, manually lift the inverter steadily and place it onto the designated bracket.



### WARNING

- The inverter is heavy. Multiple qualified personnel must work together to lift and mount it. A forklift or other suitable lifting aids may be used.
  - Single-person handling/lifting is strictly prohibited to prevent equipment fall, personal injury, or equipment damage.
4. Secure the inverter to the bracket using the screws supplied with inverter: 3 screws per side, 6 screws in total.

### Installation steps for 50 kW-01 inverter

1. Prior to inverter installation, remove the factory-fitted fixing screws on the left side of the cabinet. Keep these screws properly for later installation.
2. Align the **larger holes** on each inverter mounting bracket with the **outermost inverter assembly holes** on the cabinet.

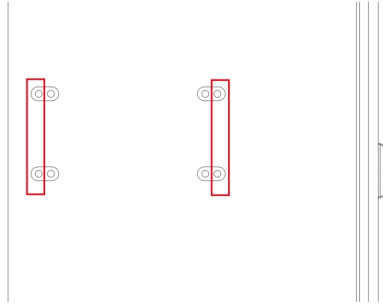

3. Ensure the larger holes on both brackets face outward. Fasten the two inverter mounting brackets to the cabinet using the factory-fitted screws.
4. Using factory-fitted fixing screws, fasten the wall bracket to the screw holes marked **C** on the pre-installed inverter brackets.

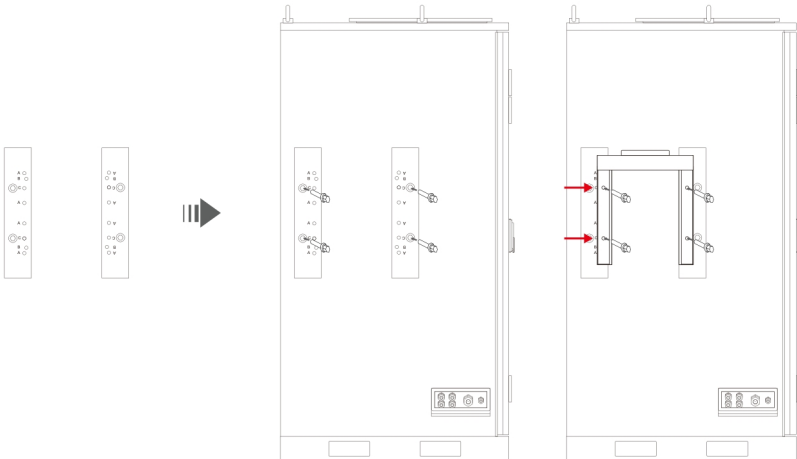

5. After the wall-mount bracket is securely fastened, manually lift the inverter steadily and place it onto the designated bracket.

### **WARNING**

- The inverter is heavy. Multiple qualified personnel must work together to lift and mount it. A forklift or other suitable lifting aids may be used.

- Single-person handling/lifting is strictly prohibited to prevent equipment fall, personal injury, or equipment damage.
6. Secure the inverter to the bracket using the screws supplied with inverter: 3 screws per side, 6 screws in total.

### Installation steps for 50 kW-02 inverter

1. Prior to inverter installation, remove the factory-fitted fixing screws on the left side of the cabinet. Keep these screws properly for later installation.
2. Align the **larger holes** on each inverter mounting bracket with the **outermost inverter assembly holes** on the cabinet.

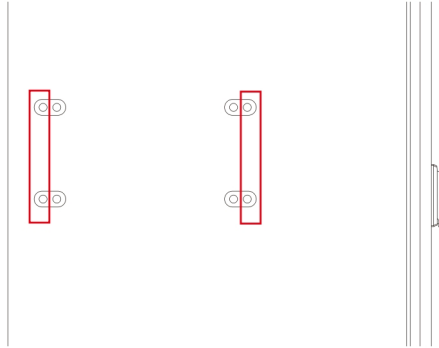

3. Ensure the larger holes on both brackets face outward. Fasten the two inverter mounting brackets to the cabinet using the factory-fitted screws

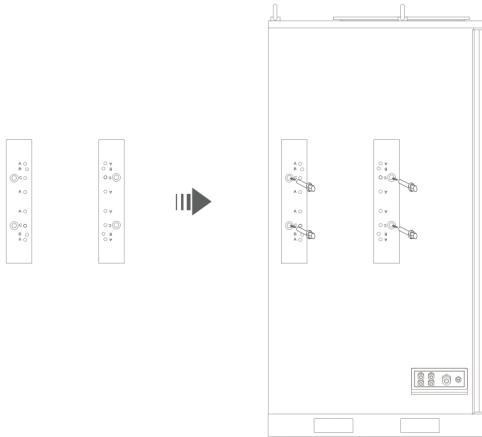

4. Using factory-fitted fixing screws, fasten the wall bracket to the screw holes marked **A** on the pre-installed inverter brackets.

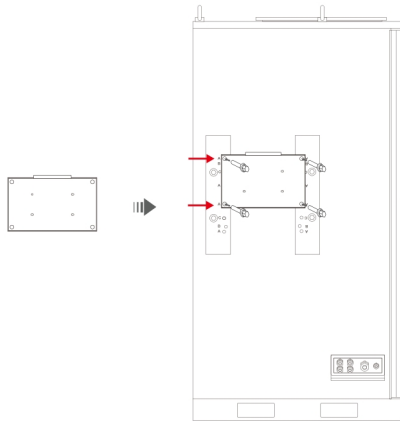

5. After the wall-mount bracket is securely fastened, manually lift the inverter steadily and place it onto the designated bracket.

**⚠ WARNING**

- The inverter is heavy. Multiple qualified personnel must work together to lift and mount it. A forklift or other suitable lifting aids may be used.
  - Single-person handling/lifting is strictly prohibited to prevent equipment fall, personal injury, or equipment damage.
6. Secure the inverter to the bracket using the screws supplied with inverter: 3 screws per side, 6 screws in total.

### 4.3.4 Install the Cable Cover

#### NOTE

- The cable cover can be installed on cabinets equipped with inverters. It is not required for cabinets used for DC parallel expansion or those configured with a PCS.

1. Remove the 10 pre-installed screws on the cabinet and the cable inlet cover. Keep these screws for later installation.

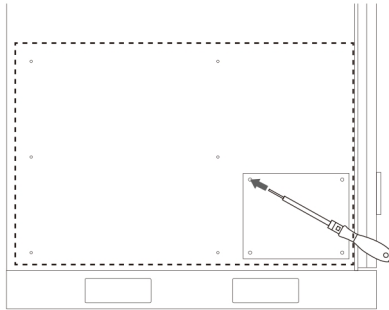

2. Slit cable grommets to match cable diameter, and then press them into the oval holes on the vertical mount plates.

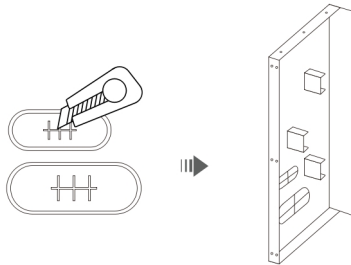

3. Secure the angled side bracket to the cabinet with the removed factory-installed screws.

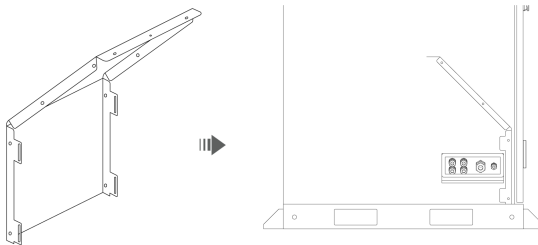

4. Align the first vertical mount plate with the side bracket: pre-fasten loosely and

then fasten the overlapping section with three provided M4\*10 screws.

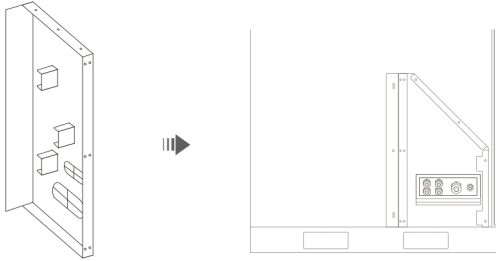

5. Secure the second vertical mount plate to the cabinet with removed factory-installed screws.

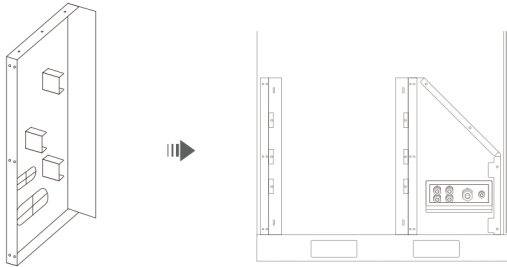

6. Fasten 3 cable management rails between the two vertical plates using the provided M4x10 screws.

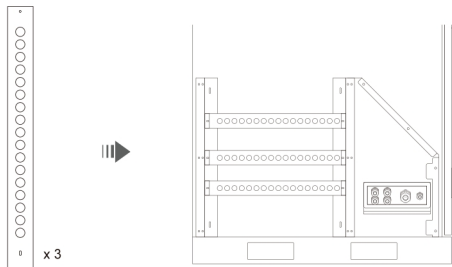

7. Complete all electrical connections as the steps in **Chapter 5**.
8. Organize cables with supplied cable ties and secure them to the cable management rails.
9. Ensure that all cables are securely connected, and install the angled side panel.

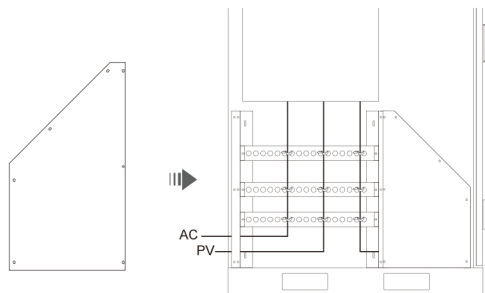

10. Install the front cover.

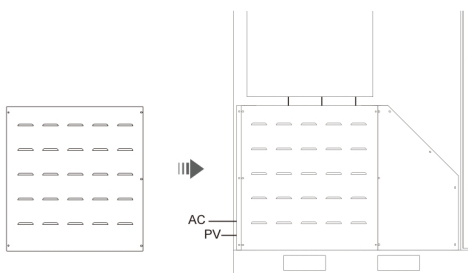

# 5 Electrical Connection

## 5.1 Safety Precautions



### DANGER

- Do not contact live parts directly without protection.
- Before cable connection, ensure that there is no voltage on the AC side and DC side.
- Do not expose the equipment to flammable or explosive gases, smoke, or any explosive environments.
- Only qualified electrical professionals can perform the electrical connection.



### WARNING

- The product can only be used in situations equipped with overvoltage protection devices.
- Do not perform electrical connections during sandstorms or when the relative humidity of the surrounding environment is greater than 95%.
- Only allow connection of “+” to “+” and “-” to “-”.
- Before connecting cables, check that the polarity of all input cables is correct. Do not pull wires and cables forcibly during electrical installation; otherwise, the insulation performance may be affected. Ensure all cables have sufficient bending space and take necessary auxiliary measures to reduce cable stress.

### NOTE

- This system must be used in conjunction with compatible hybrid inverter models. It needs to establish communication with the inverter to activate the lithium battery mode, ensuring optimal battery performance.
- After cable connection, carefully verify that all connections are correct and secure.
- When connecting to inverters or operating in parallel mode, please use the cables provided in the packing list. If other cables must be used under special circumstances, ensure they comply with relevant standards.

## 5.2 Open the Cabinet Door

The cabinet door is locked before delivery. Before cable connection, open the cabinet door as follows:

1. Slide the protective cover upward to expose the keyhole.
2. Insert the door key into the keyhole and turn it clockwise to unlock the handle.
3. Rotate the handle in the indicated direction to open the door.

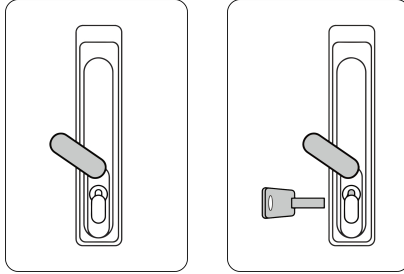

### NOTE

- After the electrical connection is complete, lock the door and keep the key.

## 5.3 Cable Connection



### WARNING

- After completing all electrical connections, perform cable management and install the front cover of the cable cover set as described in section **4.3.4 Install the Cable Cover**.

### NOTE

- The cable connections and wiring methods described herein assume the inverter is installed on the left side of the cabinet, with cables routed through the side cable inlet.
- The AC side of the device is rated for Overvoltage Category (OVC) III and the DC energy storage side OVC II.

### 5.3.1 Preparation

Prepare the following cables before electrical connection. For the full cable name and pictures, refer to **4.2 Packing List**.

Cable Type	Cable size (mm <sup>2</sup> )	Note
Grounding Cable (Cabinet Grounding)	30~50	Prepared by the user (M8 OT/DT Terminal)
Auxiliary Power Cable	18~22	Prepared by the user (E25-16 terminals for L1/2/3/N;

		M5 OT terminal for PE line)
Communication Cable	-	Included
3AWG Positive Power Cable	-	Included (for 125 kW, 80 kW and 50 kW-1 and 50 kW-2 Inverters)
3AWG Negative Power Cable	-	
1AWG Positive Power Cable	-	Included (for PCS)
1AWG Negative Power Cable	-	

Before connecting cables, pierce the rubber seal at the cabinet cable inlet using a screwdriver.

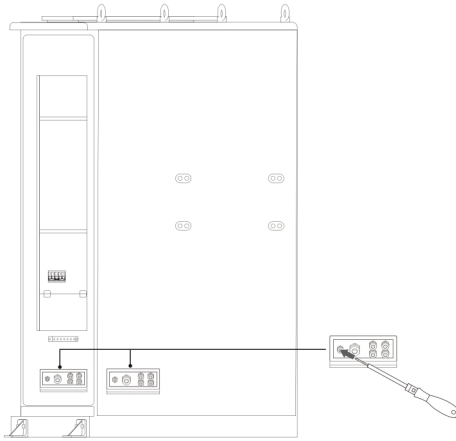

### 5.3.2 Grounding



#### WARNING

- Ensure the ground cable is securely connected to prevent electric shock.
- Either cabinet grounding or auxiliary power grounding is mandatory.



#### CAUTION

- The grounding point at the AC output port is only for protective earthing equipotential bonding and cannot replace the enclosure grounding point.
- After connecting the grounding cable, it is recommended to apply silicone grease or paint around the ground terminal.
- After completing the grounding connection, grounding resistance must be measured and must comply with applicable national/local standards and regulations.
- It is recommended to prepare a ground cable with an OT/DT terminal for better and safer grounding.

1. Remove the screws on the protective grounding port with a screwdriver. Keep the screw for later connection.
2. Align the OT/DT terminal of the ground cable with the protective grounding port, and tighten the screw using an insulated torque socket wrench to ensure a secure connection (recommended torque: 25 N·m).

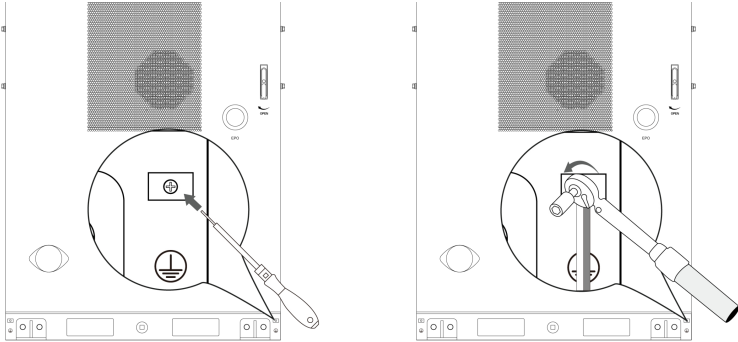

### 5.3.3 Communication Cable

1. Connect one end of the communication cable to the inverter/PCS.
2. Route the communication cable through the cabinet cable inlet.
3. Connect the other end to the PCS port on the cabinet PDU.

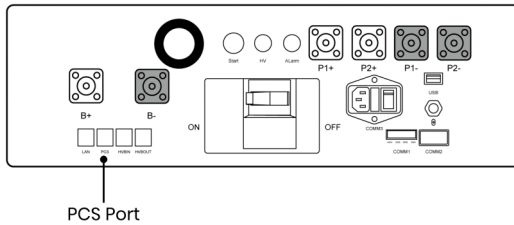

### 5.3.4 Power Cable

1. Connect the OT terminal of the positive or negative power cables to the corresponding ports on the inverter/PCS.
2. Route the cables through the cable inlet of the cabinet.
3. Install the quick-fit end of the power cable to the P+ or P- port on the PDU in the cabinet.

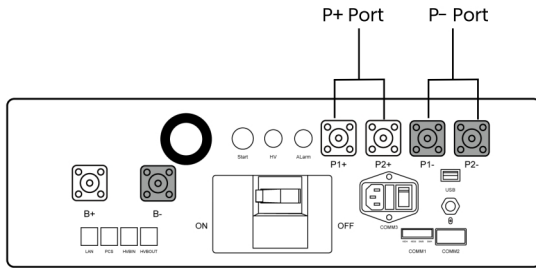

### 5.3.5 Auxiliary Power Connection

#### NOTE

- Cables for auxiliary power connection are not supplied. The maximum auxiliary power per cabinet is 4.2 kW, and cables with E25-16 terminals and 18-22 mm<sup>2</sup> cross section are recommended for future expansion. Actual specifications may be adjusted according to on-site requirements.

Follow the steps below to connect auxiliary power cables:

1. Route the auxiliary power cable through the cable Inlet of the cabinet.
2. Strip the auxiliary power cable with the wire stripper.
3. Insert the stripped L1, L2, L3, and N lines to the prepared **E25-16 terminals** and the stripped PE line to the **M5 OT terminal**.
4. Crimp the terminals with crimping pliers. Verify the conductor is securely locked in the terminal and cannot be pulled out by hand.
5. Slide the heat-shrink tubing over the crimped joint, covering the crimp and a small part of the insulation. Apply heat evenly with a heat gun until the tubing shrinks tight and seals the joint completely.
6. Insert L1, L2, L3, N lines to the corresponding auxiliary power supply ports and secure the PE line to the ground bus-bar with screws.

#### **L1, L2, L3, N Lines:**

Press the terminal block with a screwdriver to hold the port open, then insert the L1, L2, L3, and N wires into the corresponding ports.

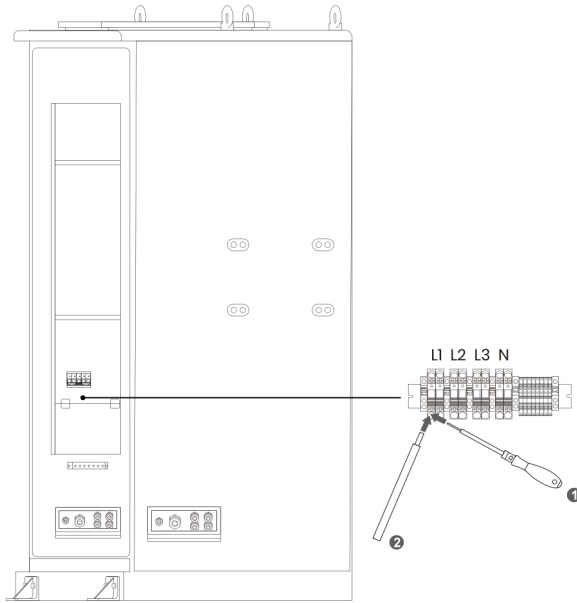

Port	Description
L1: 1-2	Connect to L1 phase of auxiliary power supply, 3P-380V/400V
L2: 3-4	Connect to L2 phase of auxiliary power supply, 3P-380V/400V
L3: 5-6	Connect to L3 phase of auxiliary power supply, 3P-380V/400V
N: 7-8	Connect to N phase of auxiliary power supply

### PE Line:

Use screws to secure the PE line to the ground bus-bar with an insulated torque socket wrench (Recommended torque: 6 N·m).

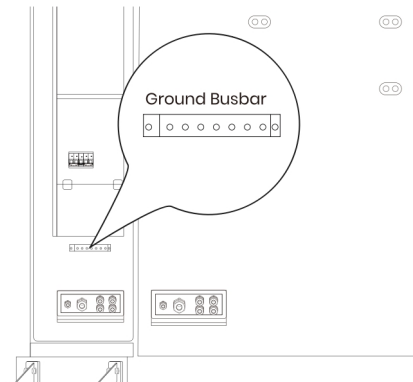

The following figure illustrates the complete wiring layout of the cabinet for reference.

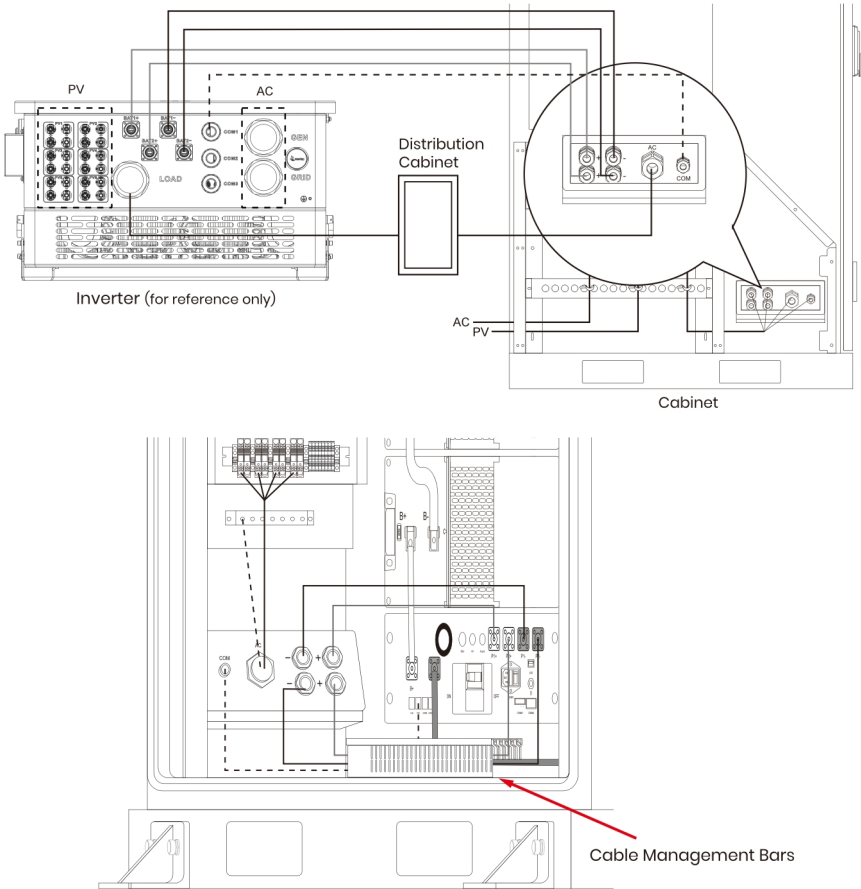

**NOTE**

- To ensure neat and orderly internal wiring, it is recommended to route and organize cables using the cable management bars.
- Select the nearest cable inlet for wiring, route cables neatly and avoid tangles.
- The inverter interface layout shown is for reference only. All wiring and connections must be performed in accordance with the actual terminal markings and technical specifications on the actual product.

## 5.4 Multi-System Connection

### 5.4.1 Communication Between Cabinets

1. Connect the first cabinet to the inverter/PCS using the provided communication cable, as described in section **5.3.3 Communication Cable**.
2. Connect one end of a second communication cable to the HVBOUT port of the first cabinet, and the other end to the HVBIN port of the second cabinet. Repeat this procedure for any additional cabinets.

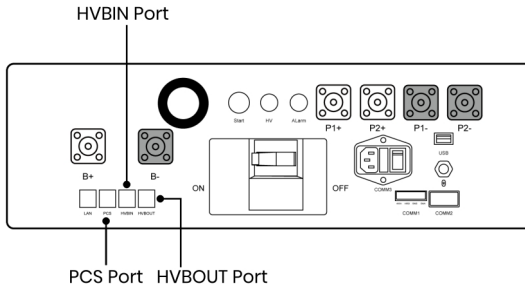

3. For the final cabinet, use the Terminal Resistor to block the HVBOUT Port.

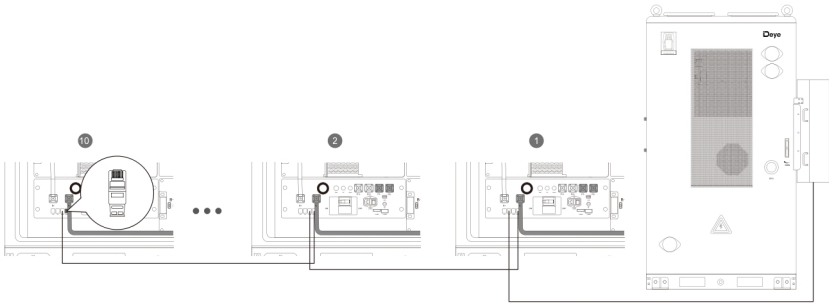

### 5.4.2 Power Transfer

#### For power transfer between cabinets

1. Connect the positive and negative power cables of the first cabinet to the inverter/PCS as indicated in section **5.3.4 Power Cable**.
2. Connect the quick-fit connector of a second positive or negative power cable to the P+ or P- port in the first cabinet.
3. Route the cables through the cable inlet of the first cabinet and into the second cabinet cable inlet.

4. Install the supplied quick-fit connector onto the OT terminal of the positive or negative power cable as follows.
  - a. Disassemble the quick-fit connector as follows.

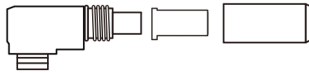

- b. Route the cable through the plug backshell first, then through the rear sealing boot, positioning both components along the cable away from the end to be processed.

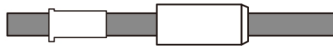

- c. Strip the insulation from the end of the cable. Recommended Stripping Length: **19 mm.**

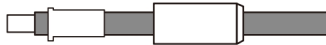

- d. Insert the stripped cable conductor fully into the terminal contact cavity of the connector plug. Tighten the plug backshell to complete the assembly.

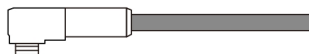
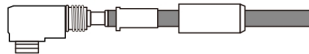

5. Connect the installed quick-fit connector to the P+ or P- port on the PDU in the second cabinet.
6. Repeat Steps 2 to 5 for any additional cabinets.
7. For the final cabinet, connect its positive and negative power cables to the cabinet's P+/P- ports. Route the cables through all intermediate cabinets toward the inverter, and insert the connectors into the ports on the inverter/PCS.

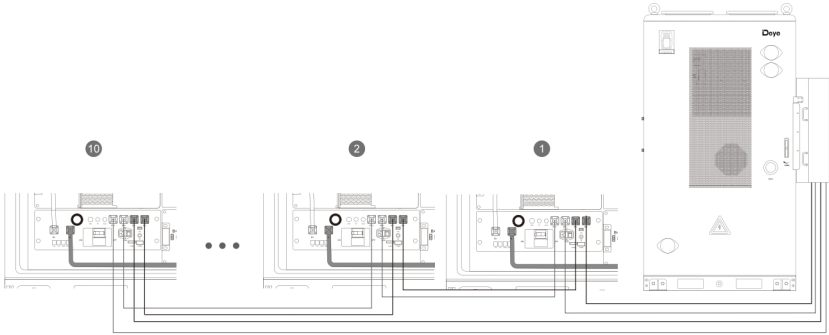

**Recommended wiring method for auxiliary power paralleling**

**NOTE**

- A maximum of 4 units can be connected per phase. The system supports up to 10 parallel units; exceeding this limit may degrade communication quality.
- If not more than 4 units are to be installed, two wiring options are available (as shown below). The first wiring method is recommended for future parallel expansion to ensure current balance and the second saves cables yet limits future expansion.

**For 2 units**

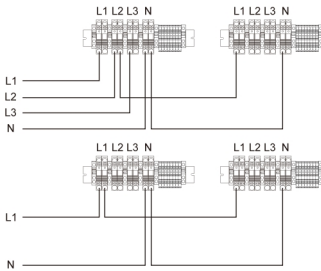

**For 3 units**

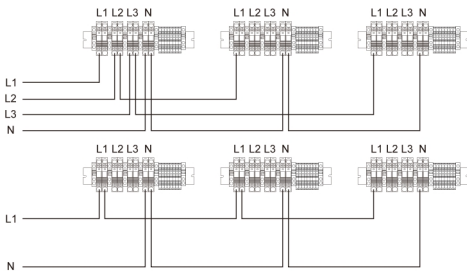

For 4 units

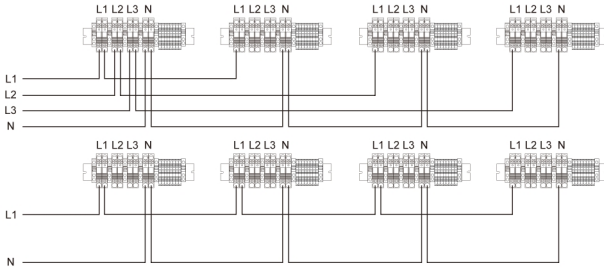

For 6 units

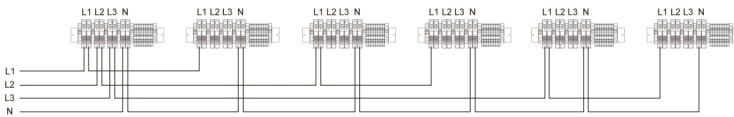

For 9 units

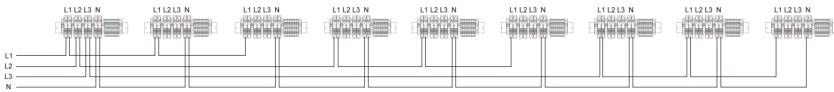

For 10 units

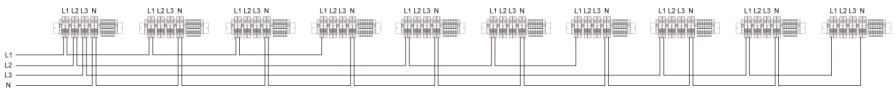

## 5.5 Post Connection Procedures

### 5.5.1 Complete Cable Cover Installation

#### NOTE

- This section describes the final steps after wiring. The detailed cable cover installation procedure has been fully covered in section **4.3.4 Install the Cable Cover**.
1. After completing all electrical connections, check all cables are connected securely.
  2. Tighten the cable gland at the cabinet cable inlet.

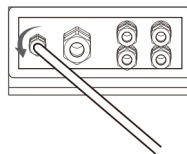

3. Use the supplied cable ties to organize cable and secure them to the cable

management rails.

4. Install the angled side panel and front cover.

### 5.5.2 Install the MSD

Plug in the MSD device after all cables have been connected correctly and firmly.

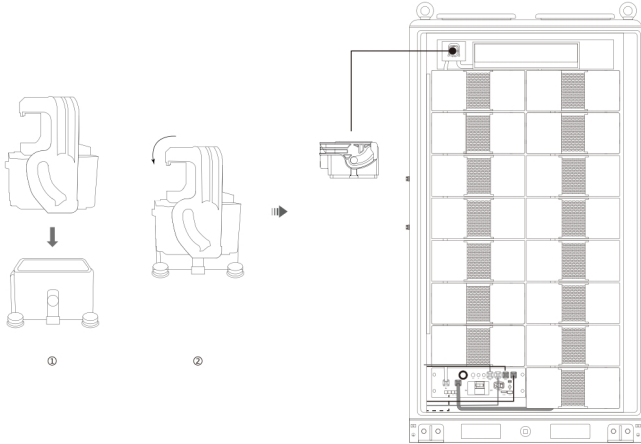

### 5.5.3 Apply Fire-Proof Mud

 **CAUTION**

- The fire-proof mud must be applied where cables pass through the cabinet bottom.
- Before applying the fire-proof mud, pull the cables slightly by hand to ensure secure connections.

After completing the wiring, use the fire-proof mud to seal the bottom cable inlet.

Only the holes through which cables are routed need to be sealed.

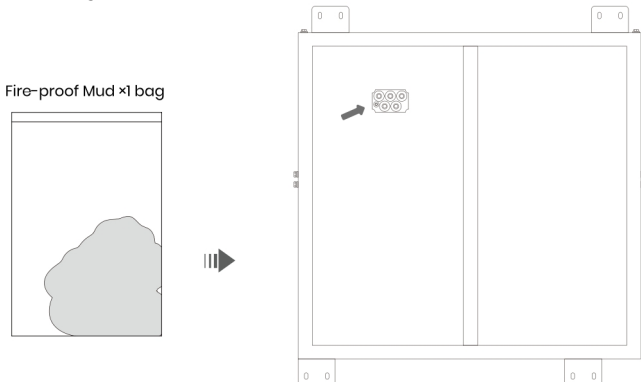

# 6 Operation

## 6.1 Check Before Power-On

No.	Item	Criteria
1	Equipment Appearance	<ul style="list-style-type: none"> <li>● Equipment is intact, no rust or paint flake-off. Repair damaged paint if any.</li> <li>● Device labels are clear. Replace damaged labels if any.</li> <li>● Door lock of each cabinet functions properly.</li> </ul>
2	Cabinet Installation	<ul style="list-style-type: none"> <li>● Installation site and foundation meets design requirements.</li> <li>● Cabinet is level and secured by mounting feet.</li> <li>● Clearance around the cabinet meets requirements.</li> </ul>
3	Cabinet Grounding	<ul style="list-style-type: none"> <li>● Cabinet grounded correctly with the ground cable securely connected to the cabinet PE terminal.</li> </ul>
4	Switch/circuit breaker	<ul style="list-style-type: none"> <li>● All circuit breakers are in the "OFF".</li> <li>● All disconnectors are in correct position.</li> </ul>
5	Cable	<ul style="list-style-type: none"> <li>● Cables are intact with sheathings wrapped properly.</li> <li>● Cable specifications meet the requirements and terminals are prepared as required.</li> <li>● Cables are connected in designated positions</li> <li>● Labels at both ends of cables are clear.</li> <li>● Cables are placed properly and with slack at bending points to avoid stress.</li> <li>● Cables are routed neatly without twists or crossovers in the cabinets.</li> </ul>
6	Cable Inlet Sealing	<ul style="list-style-type: none"> <li>● Cable inlets are sealed using cable cover or fire-proof mud.</li> </ul>
7	Ventilation/Heat Dissipation	<ul style="list-style-type: none"> <li>● Fans and cooling vents are unobstructed.</li> <li>● Air conditioner functions properly.</li> </ul>

## 6.2 Power-On



### **DANGER**

- Wear insulated gloves and use insulated tools at all times to prevent electric shock or short circuits.
- Monitor the system during power-on. If any fault is detected, power off the system immediately, rectify the fault, then resume operation.



### **WARNING**

- If the batteries become fully discharged or over-discharged during installation and commissioning, charge them promptly to avoid battery damage.
- If the installed system remains unused for 6 months or longer, it must be inspected and tested by qualified personnel before being put back into operation.
- If any circuit breaker inside the system trips, inspect the corresponding load side for faults.
- Only restore the circuit breaker after confirming no short circuit or other abnormality exists, to prevent fault escalation and potential hazards.



### **CAUTION**

- Remove all desiccants from the ESS before initial power-on and long-term operation, and dispose of them in accordance with local waste regulations.
- Clear the equipment working area, and strictly prohibit unrelated personnel and animals from entering the operation range.
- Keep foreign objects, especially metal debris, away from the battery pack to avoid short circuit risks.

### **NOTE**

- The black start function is supported when both of the two conditions are met:
  - The ambient temperature is between -10°C and 50°C.
  - The AC auxiliary power supply of the battery cabinet is fed from the LOAD ports of the designated hybrid inverters.

1. Flip up the circuit breakers **QF1**, **QF2** and **QF4**, and the **SPD MCB** in the power distribution area.

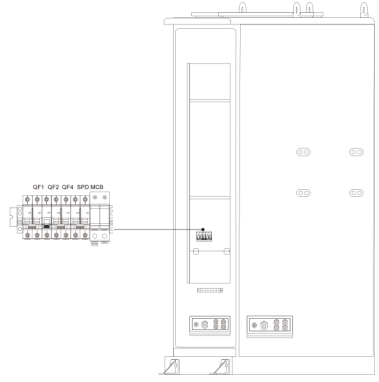

2. Flip up the circuit breaker **QF3** on the UPS.

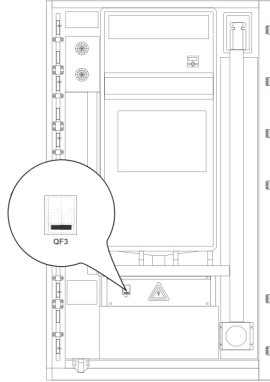

3. On the **PDU**, toggle the COMM3 switch on the PDU to the "1" position and flip the circuit breaker to **ON** position, and press the **Start** button on the PDU.

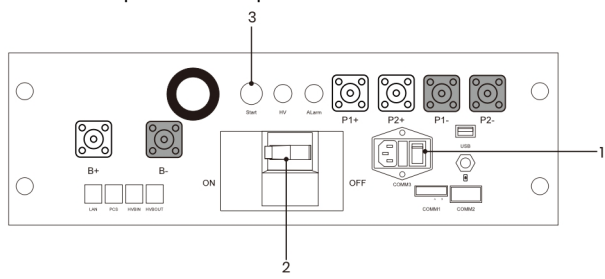

## 6.3 Power-Off

### 6.3.1 Normal Power-Off Procedure

1. Flip down the circuit breakers **QF1**, **QF2** and **QF4**, and the **SPD MCB** in the power distribution area.
2. Flip down the circuit breaker **QF3** on the UPS.
3. On the PDU, toggle the COMM3 switch on the PDU to the "O" position and flip the circuit breaker to **OFF** position, and press again the **Start** button on the PDU.

### 6.3.2 Emergency Power-Off Procedure



#### WARNING

- Do not press the EPO button during normal system operation or when no emergency condition exists.
- Only after confirming that the fault has been completely cleared can you start the system again.

In an emergency, immediately break the cover of EPO button and press the button to shut down the system.

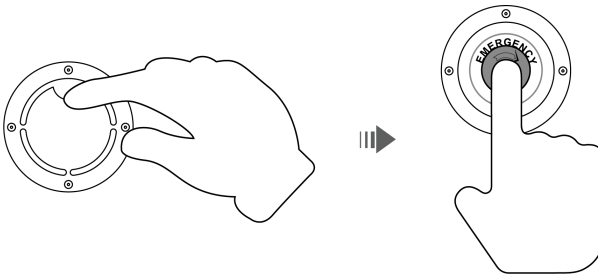

After troubleshooting, use a screwdriver to remove the broken cover, and replace it with a new cover, which is included in the accessory kit.

# 7 Product Monitoring

## 7.1 DEYE Cloud Website

### NOTE

- The DEYE Cloud Website can be used to monitor your ESS system only if you have purchased a DEYE inverter.
1. Log in to the Deye Cloud (<https://www.deyecloud.com/login>) with your account and password.
  2. After logging in to the Deye Cloud, enter the SN code of the inverter collector in the search bar (marked by the red box). The detailed information corresponding to the device will be displayed. Click the device's SN code in the table (marked by the green box) to access the **Device Details Page**.
  3. On the **Device Details Page**, click **Architecture** to navigate to the **Inverter Architecture Page**.
  4. Then, click **Battery Module** to view the corresponding battery data.

## 7.2 DEYE Cloud APP

The device can connect to the Deye Cloud App via Bluetooth. After successful login and registration, you can view information about the entire system.

### Download the Deye Cloud App

Scan the correct code to download the app.



For Android



For iOS

For more detailed instructions on using the Deye Cloud App, refer to the operation manual by scanning the provided QR code.



# 8 Maintenance

## 8.1 Safety Precautions



### **DANGER**

- Maintenance shall be performed or supervised by qualified professional personnel.
- Wear personal protective equipment (PPE) and use dedicated insulated tools to avoid electric shocks or short circuits.
- Do not smoke or have open flames in the vicinity of the equipment.
- Do not wear jewelry, watches or other metallic accessories during maintenance.
- All battery terminals must be disconnected for maintenance.
- It is forbidden to dismantle, dissect or open the battery; no serviceable parts are contained inside the battery.
- Electrolyte released from a damaged battery is harmful to skin and eyes and may be toxic; do not touch it.



### **WARNING**

- Never maintain energized batteries. Disconnect mains power and batteries before moving or reconnecting the equipment, and wait 5 minutes until the equipment powers off. Verify no hazardous voltage remains with a multimeter before maintenance.
- Improper decommissioning may cause damage to equipment. Ensure the product is decommissioned in accordance with relevant provisions before maintenance.
- Keep the equipment clear of the cable preparation area. Cable scraps entering the equipment can cause sparks, resulting in personal injury or equipment damage.
- Do not clean the equipment with water or any solvent.



### **CAUTION**

- Place a warning sign at the switch stating that the switch must not be switched on.
- Use an electroscope of the proper voltage level to verify the equipment is completely de-energized.
- Before maintenance or repair, securely connect the circuit to be serviced to the main grounding system. Remove the grounding connection upon completion.
- Insert and remove cables in accordance with regulations; violent or forced

operations are prohibited.

- Clean tools and materials promptly after maintenance, and check for any metallic objects left inside or on top of the product.
- When replacing batteries, use spare parts of the same type and specification.
- Charge your equipment in 48 hours after over-discharge.
- Contact the customer service center for any operation and maintenance queries; unauthorized operation is prohibited.

## 8.2 Maintenance Schedule

### NOTE

- Perform maintenance as required by site conditions.
- Ensure that the explosion vent panels are not blocked. Clear any debris from around these openings to prevent damage to the pressure relief devices during operation
- In sandstorm-prone areas, clean the air conditioner filter after each sandstorm with a high-pressure water gun.
- The CO detector is recommended to be zeroed annually and calibrated every 2 years. Remote and on-site zeroing are available.
- Contact the supplier within 24 hours if any abnormality occurs to the battery.

Maintenance Item	Description	Frequency
Environment & Safety	Check that temperature and humidity inside the cabinet are within reasonable ranges.	3 months
	Ensure no flammable or explosive materials around the product.	6 months
	Ambient temperature and humidity within operating ranges.	6 months
	Check heat dissipation modules and vents; clean with a vacuum cleaner if necessary.	12 months
	Fire-proof mud with good adhesion; foundation intact and smooth	12 months
Appearance & Structure	Check that status indicators are in normal condition.	1 day
	Ensure no foreign objects wrap or cover the product exterior.	1 day
	Check the air conditioner for radiator and clean the filter.	3 months

	Visual inspection of the product: no obvious paint peeling or rust, no dust at vents, fasteners secured, parameter settings normal	3 months
	Check cabinet door lock and sealing strip; no foreign matter, dust or condensed water inside	12 months
	Check internal screws for no loss or rust	12 months
	Warning labels and marks legible and intact; replace if stained or damaged	12 months
Electrical & Connections	Cables: securely connected, undamaged, no water ingress, intact insulation tape at terminals, proper routing	6 months
	Reliable grounding and equipotential bonding	6 months
Battery Pack	Proper ambient temperature/humidity, normal operating voltage and current	3 months
	No rust or foreign objects; fan operates properly	6 months
Protection & Safety Devices	Verify normal function of EPO button and equipment shutdown switches	3 months
	Cooling system: Normal operation, no pipe leakage, no abnormal noise	3 months
	Protective components: smoke/heat detectors, water leakage sensors, surge protective devices (SPD), fuses intact and functional	6 months

## 8.3 Post-Maintenance Requirements

After completing maintenance operations, follow the steps below to restore the site and archive the maintenance records:

Step	Operation
1. Cleaning & Restoration	Remove all temporary measures (e.g., grounding and warning signs) and wiring is restored to original condition. Prevent foreign objects from being left behind or personnel from inadvertently entering.
2. Power-up & Verification	Restore system power step by step per the power-up procedure. Verify that the system has no alarms and operating parameters are normal.
3. Recording & Archiving	Create traceable maintenance records, including the time, personnel and equipment status, and archive the records.

## 8.4 Storage

### NOTE

- For long-term storage, keep the original packaging and check it regularly.



### WARNING

- Keep the product far away from high-temperature heat sources, open flames, flammable and explosive areas, and all ignition sources, and do not expose it to direct sunlight or rain.
- During storage, ensure the product is completely disconnected from external equipment, with all operation indicators off.
- Store the product in a dry, clean, well-ventilated indoor area on flat, solid ground, away from strong infrared radiation, organic solvents, corrosive gases, and conductive metal dust.
- Handle with care. Dropping, collision, overturning, side placement, or tilting are strictly prohibited. Do not stack or roll the product improperly.
- Strictly comply with the storage requirements of the warning signs and other information on the packaging to avoid device damage.
- The storage area must be equipped with qualified fire-fighting facilities, including fire sand and special fire extinguishers.

### ESS Cabinet Storage Requirements

- **Storage Temperature:** 0°C ~ 35°C

- **Humidity:** 5% ~ 95% relative humidity, no condensing;
- **Altitude:** 3000 m

**Long-Term Storage (> 6 months):**

- Replace desiccants with the same specifications and quantity regularly.
- Check the outer packaging every 3 months, and replace damaged packaging immediately.
- Storage duration is calculated from the latest charge date marked on the packaging. If the allowable storage period is exceeded, report to the person in charge immediately.
- Maintain temperature and humidity per the storage requirements.

Since the batteries have been installed in the cabinet in the factory, the following **battery storage requirements** should also be aided:

1. For long-term battery storage, keep the SOC no less than 50%, complete at least one charge-discharge cycle every 6 months, charge the battery in a timely manner, and calibrate the SOC to 50%. Low SOC storage is strictly prohibited to avoid battery damage caused by over-discharge.
2. Check the battery voltage monthly if stored for more than 6 months. Storage can be continued if the voltage is higher than 51.2V; charge immediately in accordance with the specified charging strategy if the voltage is lower than 51.2V.
3. To reduce self-discharge losses during extended storage, disconnect one terminal of the positive power cable from the high-voltage box. This action cuts off the internal 12V auxiliary power supply and minimizes battery depletion.
4. Long-term storage of lithium batteries will cause capacity attenuation, so overdue storage shall be avoided as much as possible. If the allowable storage period is exceeded, contact the qualified personnel for inspection and maintenance. Do not attempt to start or operate the equipment without prior inspection.

## 9 Technical Specifications

Model	GE-F176-BC		GE-F208-B		GE-F240-B	
	-2-A3		C-2-A3		C-2-A3	
Cell Type	LiFePO <sub>4</sub>					
Module Capacity (Ah)	314					
Module Nominal Voltage (Vdc)	51.2					
Module Energy (kWh)	16.08					
Module Qty In Series	11		13		15	
System Nominal Energy (kWh)	176.84		208.99		241.15	
System Usable Energy (kWh) <sup>1</sup>	176.84		208.99		241.15	
System Nominal Voltage (Vdc)	563.2		665.6		768	
System Operating Voltage (Vdc)	440 – 642.4		520 – 759.2		600 – 876	
Rated DC Power (kW)	88		104		121	
Charge/Discharge Current(A) <sup>2</sup>	Recommended		157			
	Max. Continuous		180			
	Peak discharge @15s/25±2°C		285			
Fire Protection System	Aerosol & Water fire interface, CO gas detection, Active exhaust & Explosion venting					
Cooling Method	Smart Air Cooling					
Communication Port	CAN 2.0, RS485					
Communication protocol	CAN2.0, Modbus 485					
Operating Temperature (°C) <sup>3</sup>	-30 – 55					
Recommend Storage Temperature (°C)	0 – 35					
Humidity	5% – 95% RH (No Condensing)					
Altitude	3000m					
IP Protection	IP55					
Anti-Corrosion Level	Standard: C4-M, customizable up to C5					
Dimension (W x D x H, mm)	1303 x 1240 x 2405.5					
Weight(kg)	2150		2380		2610	
Installation Location	Floor mount					
Cycle Life	≥8000 (25±2°C, 0.5P, EOL70%)					
Certification	UN38.3, CE, IEC 62619, IEC 62477, IEC 62933-5-2, UL 9540A					

<sup>1</sup> Test conditions: 100% DoD, 0.5P charge & discharge at 25°C. System usable energy may vary due to system configuration parameters.

<sup>2</sup> The current is affected by temperature and SOC.

<sup>3</sup> Derated operation at > 45°C

# Appendix I Troubleshooting

The table below lists the fault code and corresponding meaning for the battery storage system.

<b>Code</b>	<b>Fault Description</b>
F001	Total Voltage Too High
F002	Total Voltage Too Low
F003	Charge Temperature Too High
F004	Discharge Temperature Too High
F005	Charge Temperature Too Low
F006	Discharge Temperature Too Low
F007	Voltage Difference Too Large
F008	Temperature Difference Too Large
F009	Cell Overvoltage
F010	Cell Undervoltage
F011	Pre-charge Resistor Over-temperature
F012	BMS Connector Over-temperature
F013	BMU Connector Over-temperature
F014	Charge Current Fault
F015	Discharge Current Fault
F016	SOC Too High Fault
F017	Insulation Fault
F018	Heating Film Over-temperature Fault
F019	SOC Too Low Fault
F020	Discharge Relay Adhesion
F021	Positive Main Relay Adhesion
F022	Charge Relay Adhesion
F023	Heat Relay Adhesion
F024	Ultimate Protection
F025	Power Supply Voltage Abnormal
F026	Fuse Blown
F027	BMU Address Duplicate Fault
F028	BMS Address Duplicate Fault
F029	Internal CAN Communication Failure
F030	PCS CAN Communication Failure
F031	PCS RS485 Communication Failure

F032	PCS RS485 Communication Error
F033	Fuse Total Voltage Sampling Error
F034	Internal Total Voltage Sampling Error
F035	Motor Total Voltage Sampling Error
F036	Heating Total Voltage Sampling Error
F037	Voltage Sampling Fault
F038	Temperature Sampling Fault
F039	Current Sampling Fault
F040	Current Module Fault
F041	Positive Main Relay Drive Failure
F042	Charge Relay Drive Failure
F043	Discharge Relay Drive Failure
F044	Heat Relay Drive Failure
F045	EEPROM Storage Fault
F046	Pre-charge Failure
F047	Charge Voltage Too Low
F048	BMU Communication Fault
F049	BMU Quantity Abnormal
F050	BMS Connector Temperature Acquisition Error
F051	BMU Connector Temperature Acquisition Error
F052	Pack Thermal Runaway Fault
F053	Pack Fire Fault
F054	TCP Connection Failure
F055	W5500 SPI Communication Failure
F056	LC Communication Lost
F057	BMU AFE Communication Failure
F058	Bluetooth Initialization Failure
F059	Cell Type Mismatch
F060	Single Cluster Emergency Power-off
F061	Negative Main Fuse Blown
F062	Heating Abnormality
F063	Heating Fuse Blown
F064	Water Immersion Fault
F065	Dual Protection Board MOS Open Fault
F066	Arc Fault Detection Fault
F067	Arc Fault Detection Board Communication Lost
F068	System Self-check Completed
F069	Environmental Control Board AC Communication Loss Alarm

F070	Environmental Control Board AC General Alarm
F071	Environmental Control Board Lightning Protection Alarm
F072	Environmental Control Board Exhaust Valve Alarm
F073	Environmental Control Board Lead-acid Battery Alarm
F074	Environmental Control Board Cabin Combustible Gas Alarm
F075	Environmental Control Board Battery Door Open Fault
F076	Environmental Control Board Cabin Extinguishing Agent Feedback Fault
F077	Environmental Control Board Smoke Detector Fault
F078	Environmental Control Board Temperature Sensor Fault
F079	Environmental Control Board Cabin Combustible Gas Fault
F080	Environmental Control Board Emergency Stop Fault
F081	Environmental Control Board Water Immersion Fault
F082	Environmental Control Board Communication Loss Fault
F083	Environmental Control Board CO Detector Alarm

# Appendix II Emergency Handling



## DANGER

- In the event of natural disasters (earthquake, typhoon, flood, wildfire, etc.): Prioritize personnel safety, cut off power and stop the ESS immediately.
- Do NOT operate damaged equipment without professional inspection and qualified testing after the disaster.
- Keep away from waterlogged or fire-damaged units and contact our service engineers for professional handling.



## WARNING

- When the air intake/exhaust system is operating, do NOT face the exhaust vents under any circumstance.
- Refer to the user manual/product manual for product information. Do NOT open the cabinet door if internal safety cannot be guaranteed.

### ➤ **Electric Shock:**

- 1. Cut Off the Power Supply:** Ensure your own safety, cut off the power supply immediately to avoid secondary electric shock.
- 2. First Aid for the Victim**
  - Separate the victim from the power source using an insulated object; Perform first aid such as cardiopulmonary resuscitation (CPR) on the victim.
  - Call the hospital emergency number for professional treatment.
- 3. Site Protection and Equipment Restoration:** Protect the accident scene for investigation evidence. Contact professionals to conduct a comprehensive inspection of the ESS. The system may only be put back into use after repair/replacement and qualified testing.

### ➤ **Chemical Hazards:**

- 1. Electrolyte Leakage**
  - Evacuate personnel away from the leakage area and report to relevant personnel.
  - Professionals shall safely collect and dispose of the leaked substances.
- 2. Toxic Gas Release**
  - Toxic gases may be released when batteries burn or are damaged; evacuate personnel to a safe area immediately.
  - Call the hospital emergency number for professional treatment if there are victims.

- Use gas masks, protective clothing and other equipment during hazard handling.

➤ **Mechanical Injury:**

**1. Equipment Tipping**

- Cut off the power supply and stop the ESS operation immediately when safety is ensured.
- If personnel are injured, perform first aid (hemostasis, bandaging, etc.) and call the hospital emergency number right away.
- Contact professionals to fully inspect the support structure, electrical connections, etc. The system can only be put back into use after repair/replacement and qualified testing.

**2. Battery Pack Dropping**

- If obvious odor, damage, smoke, or fire occurs, evacuate personnel immediately, call the fire department, and let professionals handle fire extinguishing and follow-up treatment.
- If no abnormality is found, professionals shall use mechanical tools to transfer the battery pack to an open, safe area, leave it to stand for 1 hour, monitor the temperature, and contact our engineers.

**3. Component Detachment**

- Cut off the power supply and stop the ESS operation immediately when safety is ensured.
- Contact professionals to repair or replace the detached parts. The system can only be put back into use after passing qualified testing.

➤ **Natural Disasters:**

**1. Earthquake (Above Level VI) / Strong Typhoon (Above Level 14)**

- Cut off the power supply and stop the ESS operation immediately when safety is ensured.
- Evacuate personnel to a safe area quickly.
- After the disaster, contact professionals to fully inspect the support structure, electrical connections, etc. The system may only be reused after repair/replacement and qualified testing.

**2. Flood**

- Cut off the power supply and stop the ESS operation immediately when safety is ensured.
- If the ESS is flooded, do NOT touch it and stay away from the waterlogged area.
- Do NOT use water-soaked batteries; contact a battery recycling company for scrapping.

- After the flood recedes, contact professionals for thorough drying and inspection of electrical components, batteries, etc. The system may only be reused after repair/replacement and qualified testing.

### **3. Wildfire**

- Clear a firebreak around the ESS before the wildfire approaches.
- Prepare sufficient fire-fighting equipment, such as fire extinguishers, fire sand, fire hoses, etc.
- Cut off the power supply and stop the ESS operation immediately.
- After the wildfire, contact professionals to conduct a comprehensive inspection, replace damaged parts, and the system may only be reused after passing qualified testing.

# Appendix III Declaration of Conformity



260211058  
www.deyeess.com

## EU Declaration of Conformity

Product: Rechargeable Li-ion Battery Storage System  
System model: GE-F240-BC-2-A3

Name and address of the manufacturer: NINGBO DEYE ESS TECHNOLOGY CO., LTD.

No.568, South Rixian Road, Binhai Economic Development Zone, Cixi, Ningbo, Zhejiang, P.R.China

This declaration of conformity is issued under the sole responsibility of the manufacturer. Also this product is under manufacturer's warranty.

This declaration of conformity is not valid any longer: if the product is modified, supplemented or changed in any other way, as well as in case the product is used or installed improperly.

The object of the declaration described above is in conformity with the relevant Union harmonization legislation: The Electromagnetic Compatibility (EMC) Directive 2014/30/EU; the Low Voltage Directive (LVD) 2014/35/EU; the restriction of the use of certain hazardous substances (RoHS) Directive 2011/65/EU & (EU) 2015/863.

References to the relevant harmonized standards used or references to the other technical specifications in relation to which conformity is declared:

EMC:	
EN IEC 61000-6-2:2019	●
EN IEC 61000-6-4:2019	●
LVD:	
IEC 62040-1:2017 EN IEC 62040-1:2019+A11:2021	●

Nom et Titre / Name and Title:

KunLei Yu  
Test Manager *KunLei Yu*

Au nom de / On behalf of:  
Date / Date (yyyy-mm-dd):  
A / Place :

NINGBO DEYE ESS TECHNOLOGY CO., LTD.  
2026-2-11 宁波德业储能科技有限公司  
Ningbo, China  
NINGBO DEYE ESS TECHNOLOGY CO., LTD

EU DoC-v1

NINGBO DEYE ESS TECHNOLOGY CO., LTD.

No.568, South Rixian Road, Binhai Economic Development Zone, Cixi, Ningbo, Zhejiang, P.R.China

# Appendix IV Electrochemical Performance and Durability

## Parameters

Parameters	Value	Test method
Rated Capacity	314Ah	Actual measurement@25℃±3℃ ①0.5C charge ②rest30min ③0.5C discharge
Capacity Fading	8000 Cycles, fade≤30%	Actual measurement@25℃±3℃ ①0.5C charge ②rest30min ③0.5C discharge, 90%DOD
Power	8038W	@25℃±3℃ charge and discharge@ 20%-80%SOC
Power Fading	10 years, fade≤30%	/
Internal Resistance	≤0.0013Ω	Actual measurement@25℃±3℃ ①0.5C CC 3.65V,CV 0.05C, Cut ②Discharge to 50%SOC,rest 3h, V0 ③discharge 0.5C,10s, V1 ④(V0-V1)/157
Increased internal Resistance	10 years ,Increased≤30%	/
Energy efficiency	95%	Actual measurement@25℃±3℃ ①0.5C CC 3.65V ②Discharge to 2.5V, E0 ③0.5C CC 3.65V, E1 ④E0/E1
Energy efficiency Fading	10 years ,fade≤3%	/
Cycle Life	≥8000@70%SOH, 10 years	Actual measurement@25℃±3℃ ①0.5C charge ②rest30min ③0.5C discharge, 90%DOD