

Deye

User Manual

Model: MC-L430-2H3

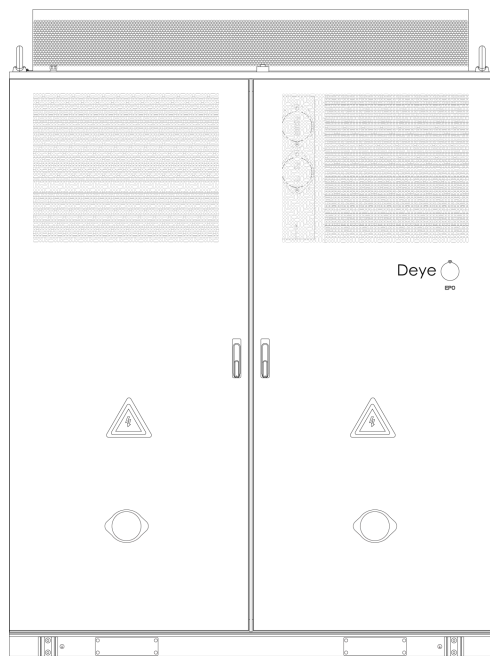

Contents

- 1 General information 4
 - 1.1 All Rights Reserved 4
 - 1.2 About This Manual 5
 - 1.3 Intended Use 5
- 2 Product Description 6
 - 2.1 Product Introduction 7
 - 2.2 Application Scenarios 7
 - 2.3 Product Size 9
 - 2.4 External Overview 10
 - 2.5 Internal Overview 12
 - 2.6 Components 14
- 3 Installation 21
 - 3.1 Materials Required 21
 - 3.2 Moving Heavy Objects 24
 - 3.3 Unpacking 27
 - 3.4 Hoisting 29
 - 3.5 Installation 33
- 4 Electrical Connection 45
 - 4.1 Preparation before Connection 45
 - 4.2 Cable Connection 48
 - 4.3 After Connection 54
- 5 Operation Instructions 55
 - 5.1 Powering on the Equipment 55
 - 5.2 Powering Off The Equipment 61

6 Maintenance	62
6.1 General Maintenance	62
6.2 Maintenance Schedule	64
7 Fire suppression system	76
8 Cloud Platform	81
9 Troubleshooting	82
10 Repair Paint Damage	83
10.1 Prerequisites	83
10.2 Paint Repair Description	83
11 Emergency Handling	89
11.1 Battery Falling or Strong Impact	89
11.2 Flood	89
11.3 Fire	90
11.4 Fire Alarm Horn/Strobe	90
11.5 Gas Exhaust	90
11.6 Extinguishant Release or Fire	91
12 Storage	92
12.1 ESS Storage	93
12.2 Battery Storage	96
12.3 PCS Storage	97
13 Transport	98
14 Environmental Disposal	100
15 Technical Specifications	101
16 EU Declaration of Conformity	102

Annex I-Manufacturer Self Declaration103

1 General information



Warning!

Read and follow carefully all safety warnings, instructions, illustrations and specifications provided with this product. Failure to follow instructions mentioned may results in electric shock, fire or serious injury.

Save all warnings and instructions for future reference.

1.1 All Rights Reserved

No part of this document can be reproduced in any form or by any means without the formal permission of the manufacturer .

Trademarks and Permissions

The trademarks used in this manual are owned by the manufacturer. All other trademarks or registered trademarks mentioned in this manual are owned by their respective owners.

Software Licenses

* It is prohibited to use data contained in firmware or software developed by the manufacturer, in part or in full, for commercial purposes by any means.

* It is prohibited to perform reverse engineering, cracking, or any other operations that compromise the original program design of the software developed by the manufacturer.

Disclaimer

“DANGER”, “WARNING”, “CAUTION”, “NOTICE” and “NOTE” in this manual do not represent all safety matters that should be followed, and you must also comply with relevant international, national or regional standards and industry practices. The manufacturer shall not be liable for personal injury,

property loss, product damage and subsequent losses under the following circumstances:

- * Damages caused by force majeure, including earthquake, flood, volcanic eruption, mudslide,, lightning, fire, war, military conflict, typhoon, hurricane, and so on.
- * Failure to comply with the provisions of this manual.
- * The installation, operation and storage environment does not meet the relevant international, national or regional standards;
- * Incorrect use of this product.
- * Unauthorized or unqualified personnel repair the product, disassembly the rack and perform other operations.
- * Use of unapproved spare parts.
- * Unauthorized modifications or technical changes to the product or software.
- * Incorrect shipment by yourself or the third party commissioned by you.
- * Unsatisfactory materials and tools from you own that do not meet the relevant international, national or regional standards.
- * Damage caused by yourself or the third party's negligence, intent, gross negligence, improper operation, or other accidents not caused by Deye.

1.2 About This Manual

This manual mainly describes the product information, guidelines for installation, operation and maintenance. In this manual, “equipment” or “device” refers to relevant product, software, part, spare part or service, etc; “The manufacturer” refers to the producer, seller or service provider of the equipment.

1.3 Intended Use

The product is a high-voltage lithium-ion energy storage system. It is characterized by high integration, good reliability, long service life, wide working temperature range, etc. The system is modular. It provides a

reliable backup power supply for private and commercial use, such as supermarkets, banks, schools, farms and small factories, to smooth the load curve and achieve peak load transfer. It can also improve the stability of renewable systems and promote the application of renewable energy. Misuse or abuse caused by unauthorized use may result in personal injury or property loss. If that happens, the user, instead of the manufacturer, shall bear liability.

2 Product Description

2.1 Product Introduction

The ESS mainly consists of lithium battery packs , power converter system (PCS), thermal management system and fire suppression system .

It plays a significant role in reducing electricity costs, ensuring power reliability, integrating renewable energy, and optimizing energy management.

2.2 Application Scenarios

The energy storage system has a wide range of application scenarios, which can be described as follows:

- Electricity saving:
 - Cut peak and fill valley to reduce electricity bills;
 - Demand control reduces capacity chargers;
- Scenery tolerance:
 - The remaining electricity emitted by the photovoltaic during the day is stored for the night discharge to smooth the output fluctuations of the wind power;
- Optical storage micro-grid:
 - Electricity can be saved, and applications such as standby power supply can provide stable power supply for islands, mountains and other areas that cannot be connected to the grid.
- Power expansion:
 - When the power distribution capacity cannot meet the load requirements, the power is discharged to meet the load requirements and achieve virtual capacity expansion.
- Standby power supply:
 - Discharge in the case of power outage or power restriction to ensure

power consumption

- Demand and response:
 - Receive power grid dispatching and enjoy dispatching subsidies

2.3 Product Size

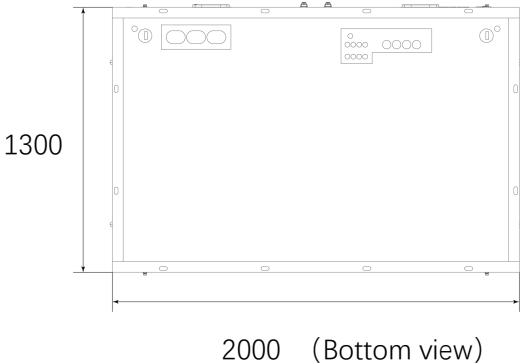
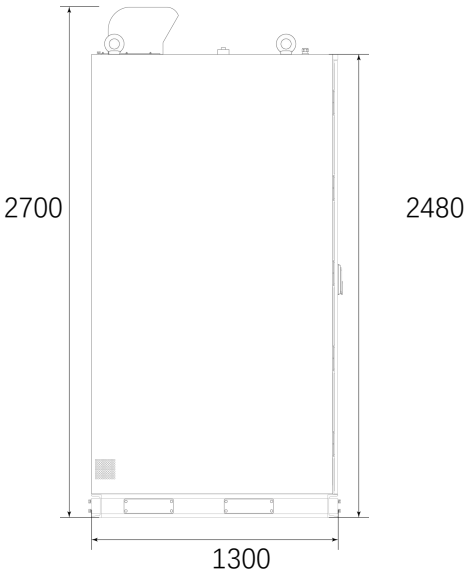
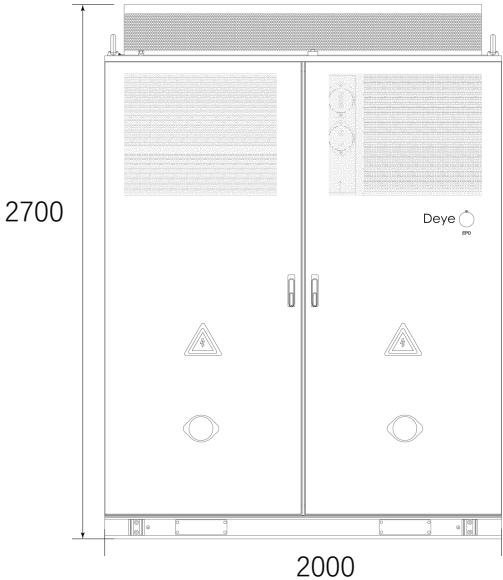

Unit:mm

2.4 External Overview

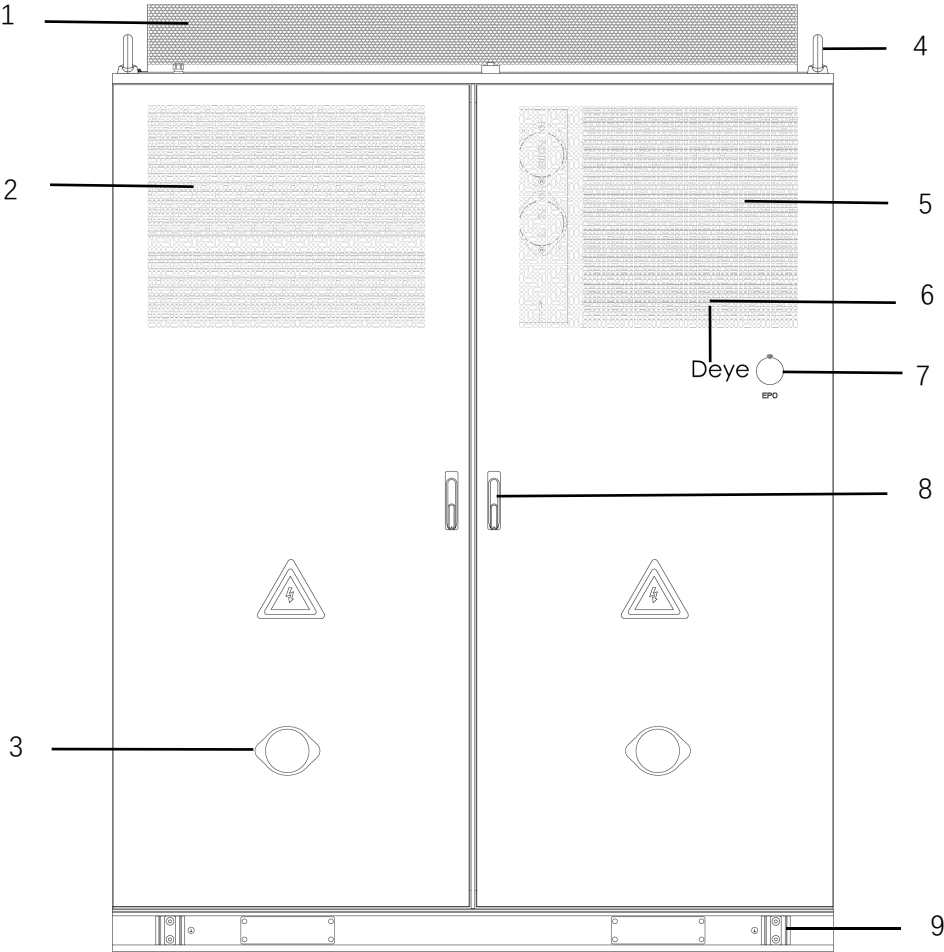

No.	Item	No.	Item
1	Air outlet	6	Status indicator
2	Air inlet of liquid cooling system	7	Emergency stop (EPO)
3	Intake valve×2	8	Door lock×2
4	Eyebolts×4	9	Protective earth×2
5	Air inlet of PCS		

2.5 Internal Overview

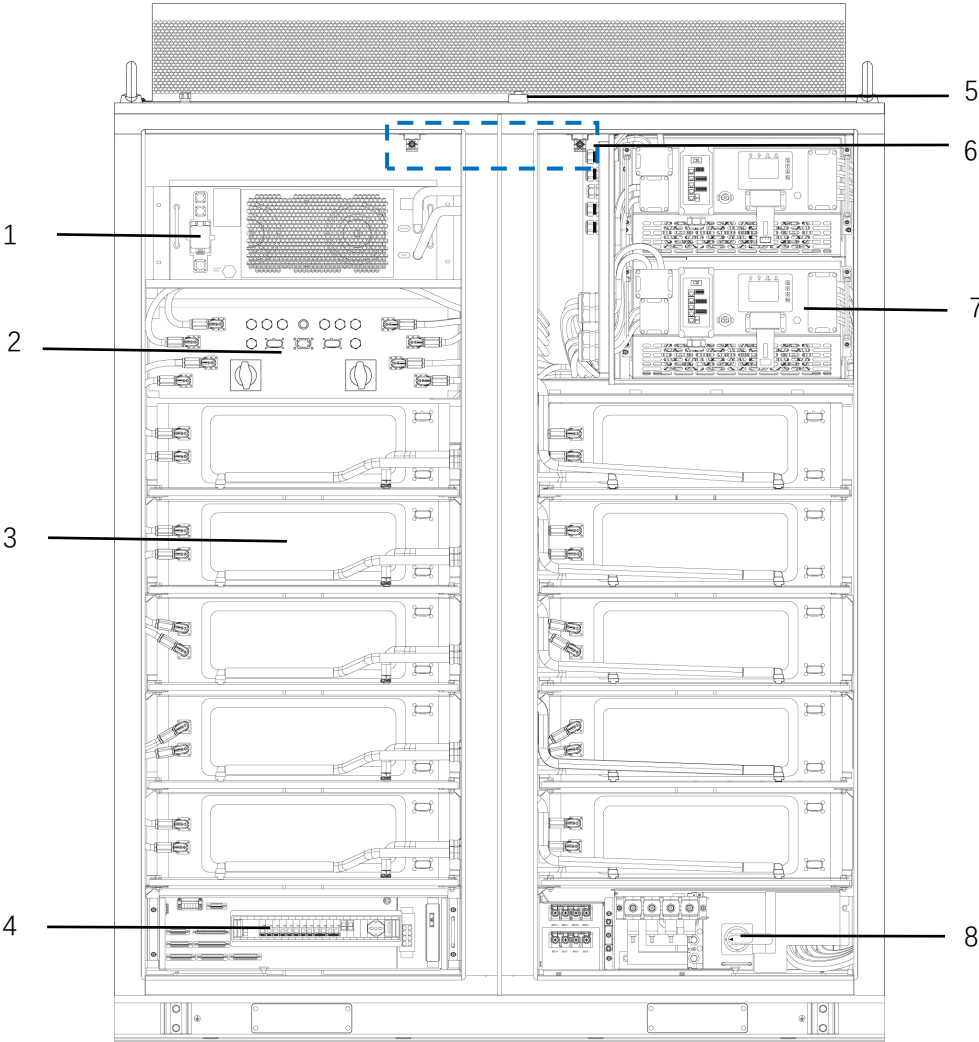

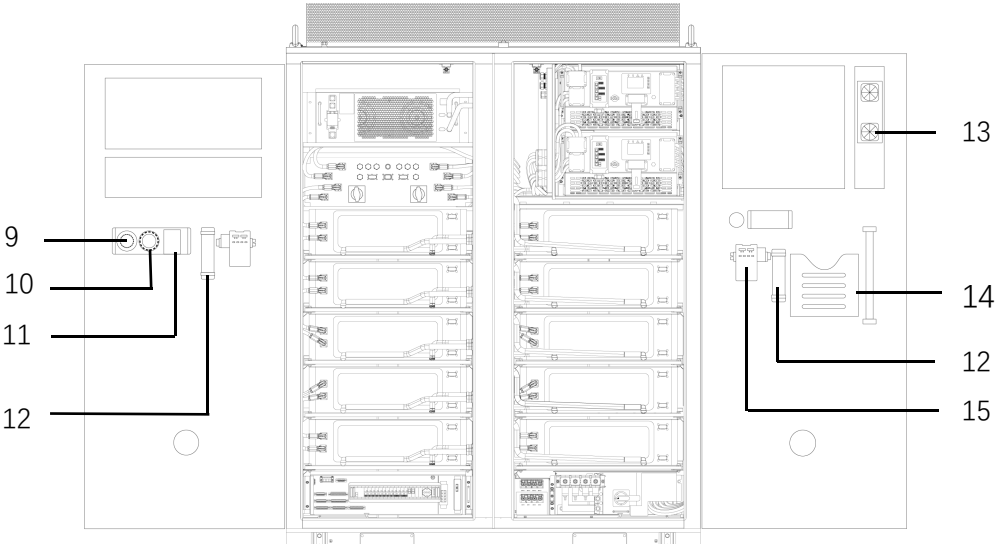

No.	Item	No.	Item
1	Liquid cooling system	9	Heat detector
2	DC power distribution unit (DC PDU)	10	Smoke detector
3	Battery pack×10	11	Gas detector
4	Control box	12	Thermal aerosol device ×2
5	Water inlet (Water Fire Suppression System)	13	Exhaust fan×2
6	Limit switch	14	Document holder
7	PCS×2	15	Dehumidifier×2
8	AC power distribution unit (AC PDU)		

2.6 Components

2.6.1 Battery Pack

- Battery charging: the electricity from the mains or other power supplies is converted by the PCS into DC electricity, which is then stored in batteries.
- Battery discharging: the electricity released by batteries is converted by the PCS into AC electricity, which is then supplied to loads.

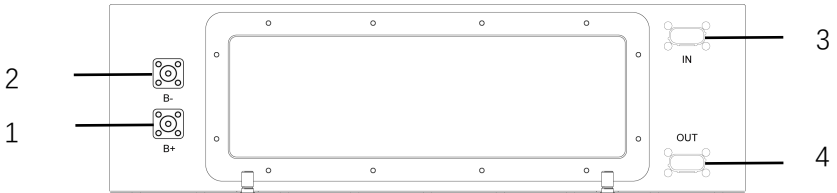

NO.	Designation	Description
1	B+	Positive battery output terminal
2	B-	Negative battery output terminal
3	COMM IN	Communication input terminal
4	COMM OUT	Communication output terminal

2.6.2 PCS (SUN-100K-PCS01HP3)

The PCS converts the DC voltage discharged from the ESS into specified AC voltage and converts AC voltage into DC voltage to charge the ESS. Refer to the separate **PCS manual** provided with this document for more information.

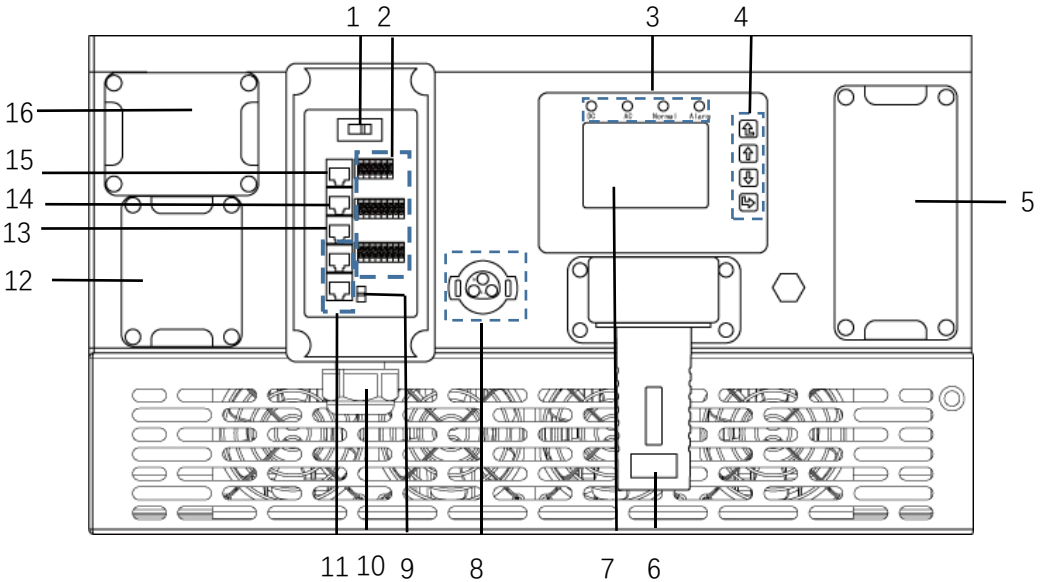

No.	Item	No.	Item
1	AC switch 2 (to control auxiliary power supply)	9	AC switch 1(to control resistance switching)
2	Function port	10	Inlet of cables
3	Indicators	11	Parallel port
4	Function buttons	12	Battery input
5	AC input/output port	13	MPPT-CAN port
6	Interface for logger	14	BATBMS port
7	LCD display	15	LCD 485
8	Auxiliary power port	16	MPPT input

2.6.3 DC PDU

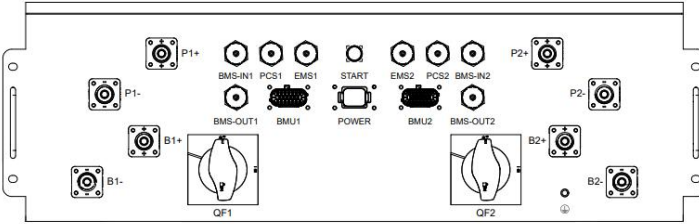

Designation	Description
P1+/P2+	Positive PCS input terminal
P1-/P2-	Negative PCS input terminal
BMS-IN1/BMS-IN2	Communication input port when multiples of DC PDU are in parallel
BMS-OUT1/BMS-OUT2	Communication output port when multiples of DC PDU are in parallel
PCS1/PCS2	RJ45 port for Battery-PCS closed-loop communication
EMS1/EMS2	BMS-EMS communication port
START	A device to control the startup and shutdown of the DC PDU
BMU1/BMU2	BMS-BMU communication port
B1-/B2-	Negative battery input terminal
B1+/B2+	Positive battery input terminal
POWER	DC24V PDU control power input/output interface
QF1/QF2	BAT MCCB

2.6.4 AC PDU

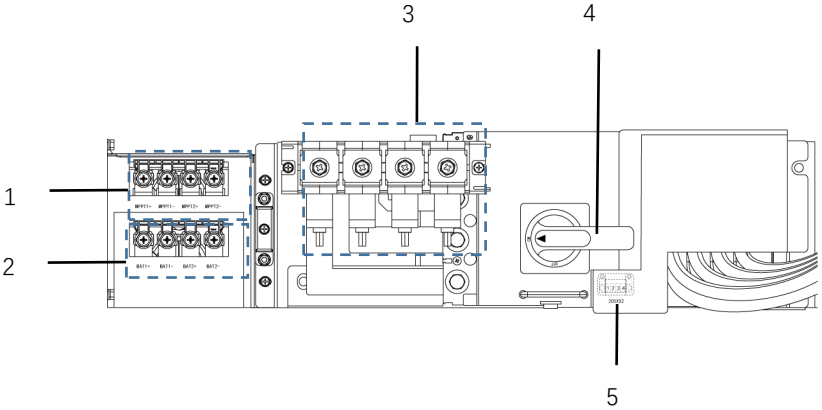

NO.	Designation	Description
1	MPPT input port	Connection position of positive and negative MPPT terminal
2	Battery input port	Connection position of positive and negative battery terminal when multiples of AC PDU are in parallel
3	Grid input port	Connection position of Grid input terminals
4	AC circuit breaker	A device used to manually control the AC power supply.
5	AC auxiliary power output port	Connection position of AC220V auxiliary power

2.6.5 Liquid Cooling System

The liquid cooling system is a device that uses liquid as a cooling medium to absorb and dissipate heat. Its main function is to achieve cooling, temperature control, and constant temperature effects by circulating coolant around objects that need cooling through a liquid circulation system . It can effectively dissipate the heat in the coolant and, due to the use of liquid circulation cooling methods, can achieve a wide range of temperature control, providing precise and uniform temperature regulation.

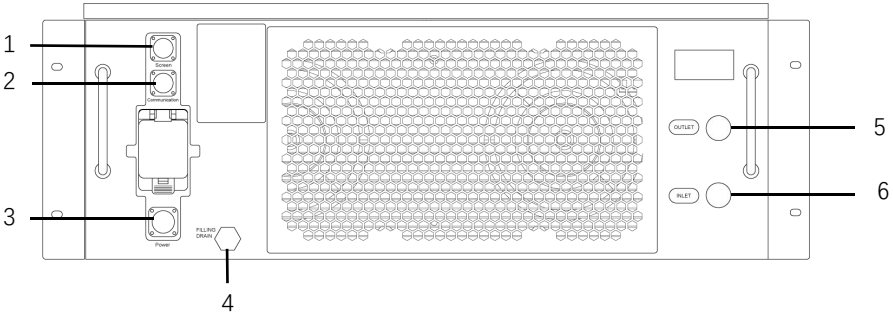

NO.	Designation	Description
1	Screen	Connecting with the master computer
2	COM	The port for commissioning
3	POWER	Connecting with the power supply, 230V/50HZ/60HZ
4	Filling/Drain	Liquid injection/drain port
5	OUTLET	The liquid cooling system's output port for delivering coolant to the battery.
6	INLET	A port that the coolant flows through and returns to the liquid cooling system after circulation.

2.6.6 EPO

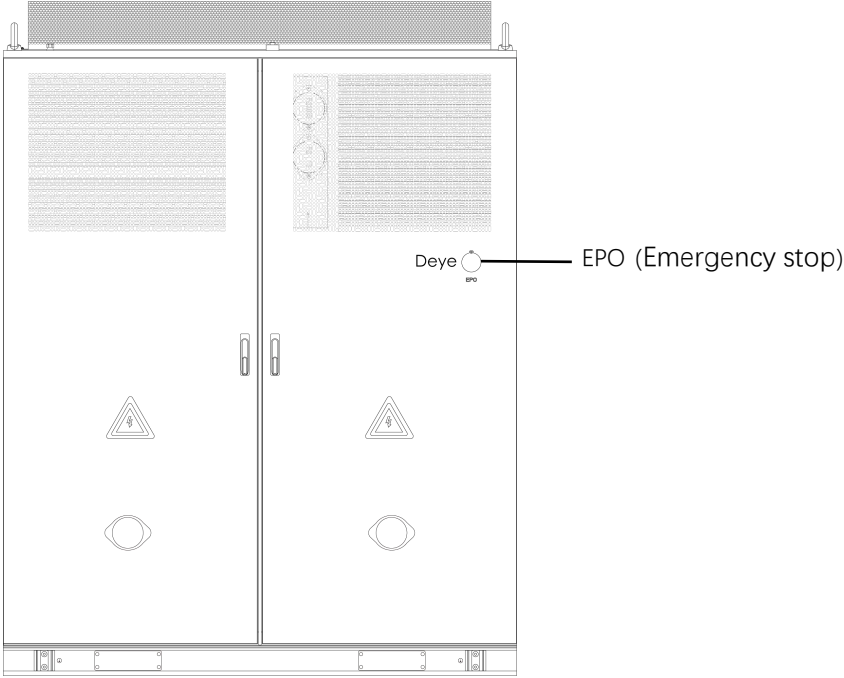

EPO (Emergency stop)

When in the emergency, press the EPO to shut off the system at once.

Notice !

Do not stop the ESS through the EPO if the system is running normally or the operator does not encounter with emergent conditions.

2.6.7 Status Indicator

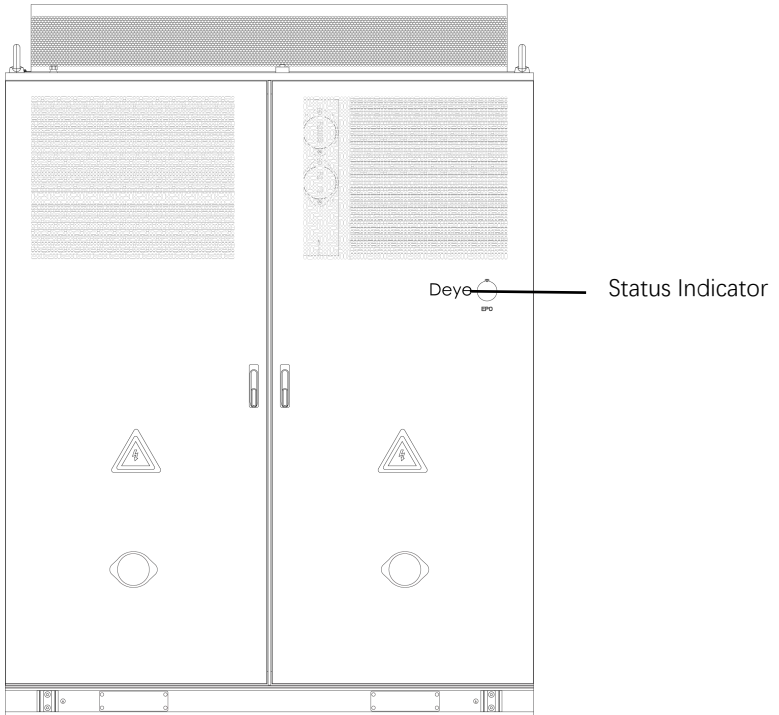

The status indicator is designed to display the equipment's state by illuminating the imprinted "DEYE" in color.







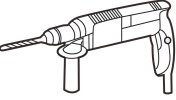
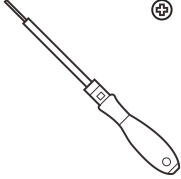
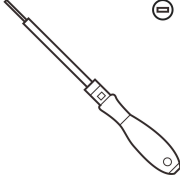
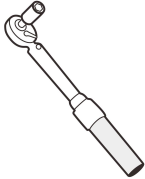
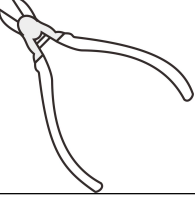
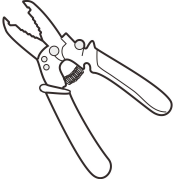
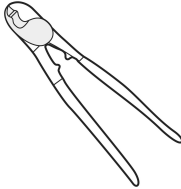
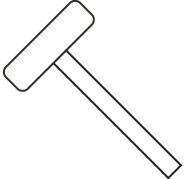
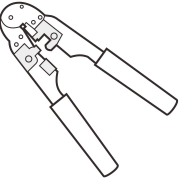
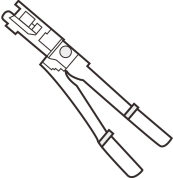
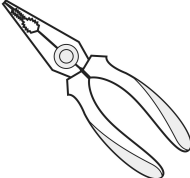



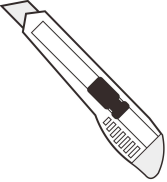
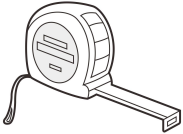
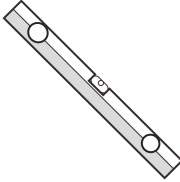
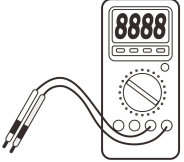
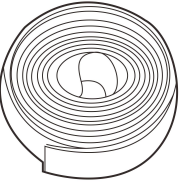
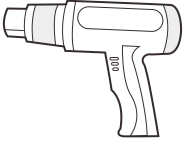
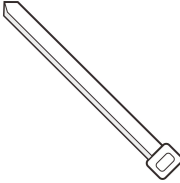

State	Description
DEYE (Blue)	The system is in standby or discharge state.
DEYE (Green)	The system is in charge state.
DEYE (Yellow)	The system generates an alarm.
DEYE (Red)	The system has a fault and has entered the protection state.

3 Installation

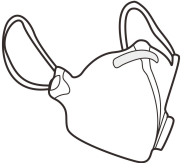
3.1 Materials Required

Tools			
			
Hammer drill	Phillips insulated torque screwdriver	Flat-head insulated torque screwdriver	Insulated torque socket wrench
			
Diagonal pliers	Wire stripper	Cable cutter	Rubber mallet
			
RJ45 crimping tool	Hydraulic pliers	Needle-nose pliers	Marker

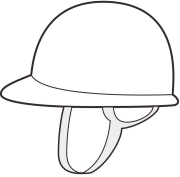
			
Utility knife	Steel measuring tape	Level	Multimeter DC voltage measurement
			
Heat shrink tubing	Heat gun	Cable tie	Insulated ladder
			
Powered industrial forklift	Crane		
Personal Protective Equipment			
			
Insulated gloves	Protective gloves	Goggles	Dust mask

			
Insulated shoes	Safety helmet	Protective suit	

3.2 Moving Heavy Objects

After arrival of your goods, perhaps you need move it to designated working area. Refer to the following picture for movement of heavy objects.

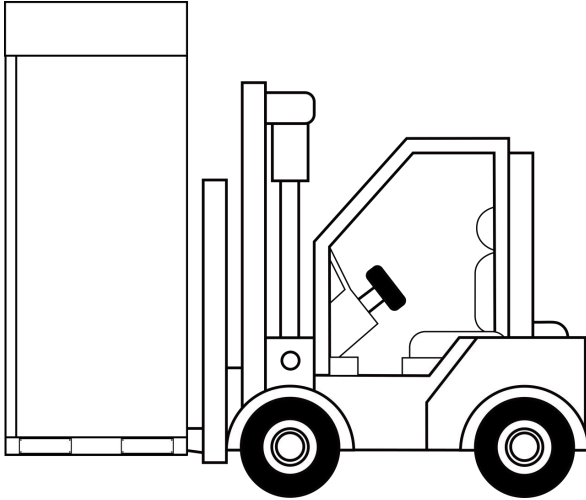

Equipment requirements		
Bearing capacity		>5t
Fork	Fork length	$\geq 2.5\text{m}$
	Width	80mm~160mm
	Thickness	25mm~70mm
Forklift lifting height		When the foundation height $\leq 0.3\text{m}$, the lifting height $\geq 2\text{m}$; when the foundation height $> 0.3\text{m}$, the lifting height shall be increased accordingly

When moving your product:

- Keep at least 2m away from the forklift during operation.
- No passengers are permitted to stand on or be lifted by forklifts.
- Do not overload forklifts or raise loads too high, as this can affect overall stability.
- Maintain speeds below 3mph and avoid sharp turns.
- Before reversing, the forklift operator must check behind them and ensure it is safe to proceed.
- When reversing in confined spaces, a spotter is needed, who directs the forklift operator.
- Use caution when lifting this load on uneven surfaces.
- Never operate the forklift on slopes ≥ 5 degrees.
- During movement, avoid tilting the cabinet or placing it upside down. If the cabinet must be tilted or inverted, please straighten it as soon as possible, and the cabinet needs to be left standing for 2 hours before it can be powered on.
- Suggest to insert the forklift tooth into the position indicated by the "Forklift fork insertion: in the package material. See the following figure.
- When lifted heavy unbalanced load, refers to the marking for center

of gravity location.

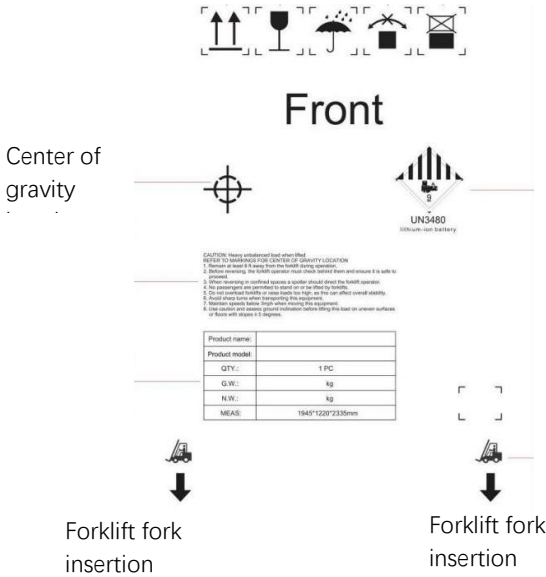



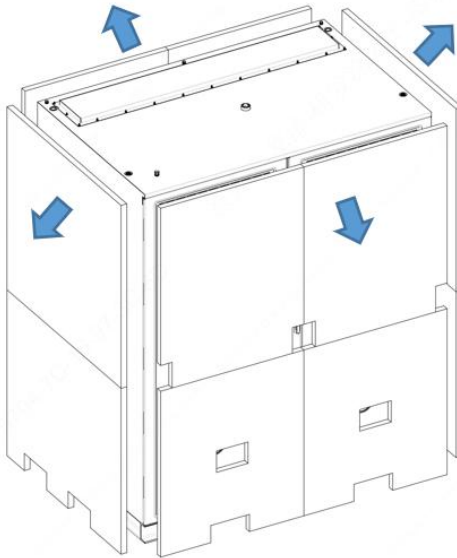

3.3 Unpacking

Warning!

- After setting up the equipment well, carefully unpack the package so as to avoid scratching equipment.
- If possible, do not remove the transport packaging before arrival at the installation site.
- After unpacking, check whether the fasteners and removable parts are missing. If they are missing, please contact you vendor at once.
- Keep the equipment stable during unpacking.
- If the installation environment is not friendly to the equipment, take measures to prevent failure inside the battery caused by condensation or dust corrosion (for example, cover with woven cloth or dust cover).
- When it comes to package, EPE foam is broadly used for most of products, which characterizes with anti-shock and easy-disassemble. It is possible to unpack the equipment with a tool like a cutter or knife.

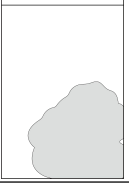
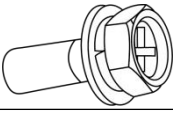

After unpacking the equipment, check that the deliverable contents are intact and complete, and free from any damage. If any items listed in the *Packing List* is missing or damaged, contact your dealer or call service hotline: **+86-0574-86320560**.

Packing List		
		
M16*150 Expansion bolt ×8 pcs	Cover Plate ×8 pcs	M10*35 Hexagon combination screw ×8 pcs
		
Air outlet×1 pc	M30 Hanging ring ×4 pcs	Fire-resistant mud 2.kg
		
M6*16 Cross-recessed hex head combination bolt×32 pcs		

3.4 Hoisting

3.4.1 Hoisting Equipment



Warning!

- The hoisting personnel must be trained and qualified until they can take up the post.
- Use only approved lifting equipment to move the battery cabinet system.



Warning!

- Never operate the lifting equipment in bad weather, such as typhoon, heavy rain, thick fog, thunder and so on.
- Before hoisting, ensure that the crane and hoisting ropes meet the load-bearing requirements.
- Do not drag the cabinet when assembling or disassembling the hoisting equipment. Otherwise, the cabinet may be scratched.
- Do not lift or move the equipment after installing batteries into the energy storage system.
- Ensure that all doors of the equipment are closed and locked before hoisting.

3.4.2 Installing the Hanging rings

1. Remove four M30*40 hexagon screws that are preset at the factory to prevent dust or other foreign objects entering the equipment. See the Figure.1.
2. Insert the four hanging rings into holes on the top of the machine and then turn them clockwise until they are secured firmly. See the Figure.2 and Figure.3.

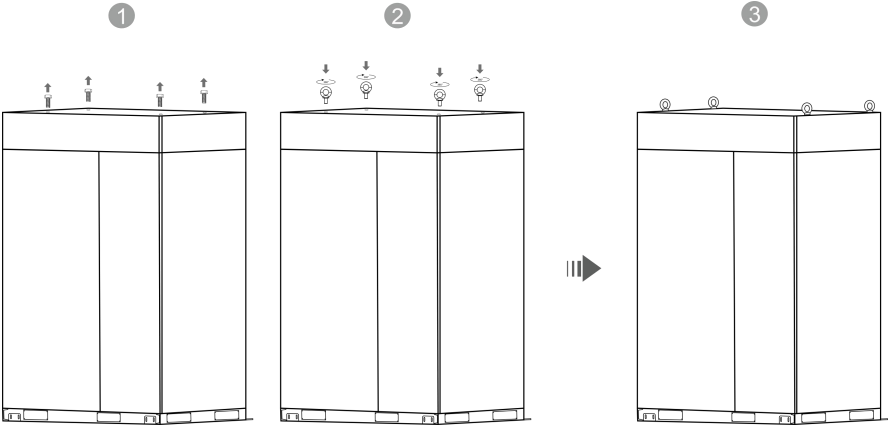

Figure.1

Figure.2

Figure.3

3.4.3 Hoisting the ESS

 **Warning!**

Remember to make sure that your device is connected to the lifting tool correctly and firmly before hoisting. Failure to do so may result in product damages, serious injury, even death.

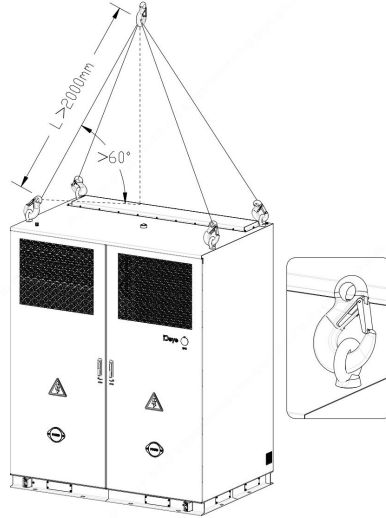

Figure.1

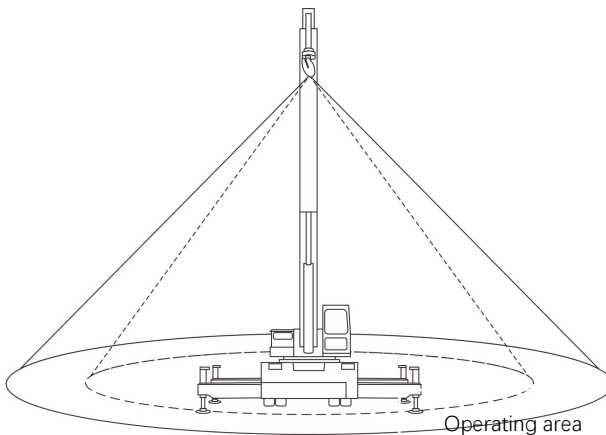

Figure.2

-
- Ensure that all sling connections are safe and reliable, and that the lengths of the slings connected to the corner fittings are equal. See the Figure.1
 - Do not stand within 0.5-1m of the lifting area! During the whole lifting process, no one is allowed to stand under the boom or the work station. See the Figure.2
 - A professional instructor is needed in the whole hoisting process.
 - The length of the sling can be adjusted appropriately according to the actual requirements of installation site.
 - During the lifting process, the devices must be stable and not skewed.
 - Please lift the devices from the bottom.
 - It is recommended to hoist the equipment from left to right or from right to left to ensure the smooth hoisting.
 - Ensure that the crane position is suitable, no long distance hoisting.
 - The equipment should be hoisted vertically and should not be dragged on any surface during hoisting.
 - Do not shake the crane in order to avoid sudden drop or shock against equipment.
 - Hoisting should be handled gently, and the cabinet should fall slowly and smoothly to avoid shock against equipment.

3.5 Installation



Warning!

- Your product is delivered without full charge. It is recommended to make your equipment charged within three months.
- Assembly must be carried out in accordance with the design, technological requirements, regulations and relevant standards.
- The parts must be cleaned before assembly, free of burrs, flash edges, oxide, rust, sand, dust and stains.
- The parts shall not be bumped, scratched or rusted during assembly.
- Wear appropriate personal protective equipment at all times during any assembly operation on site. The following personal protective equipment is considered a minimum requirement:
 - In a dry environment, wear S3 safety shoes .
 - On rainy or wet ground, wear S5 safety boots .
 - Wear flame-retardant work clothes.
 - Wear flame-retardant work pants.
 - Safety gloves.

3.5.1 Installation Requirements

3.5.1.1 Installation Personnel

- Only qualified professionals or trained personnel are allowed to install, the equipment.
 - Professionals: personnel who are familiar with the working principles and structure of the equipment, trained or experienced in equipment operations and are clear of the sources and degree of various potential hazards in equipment installation.
 - Trained personnel: personnel who are trained in technology and safety

have required experience, are aware of possible hazards on themselves in certain operations and are able to take protective measures to minimize the hazards on themselves and other people.

- Personnel who plan to install the equipment must receive all necessary safety precautions and local relevant standards.
- Only qualified professionals are allowed to remove safety facilities and inspect the equipment.
- Knowledge of electronic, electrical wiring and mechanical expertise, and be familiar with electrical and mechanical schematics.
- Understanding and complying with this document and other applicable documents.

3.5.1.2 Installation site requirements



Danger!

Do not expose the equipment to flammable or explosive gas or smoke.
Do not perform any operation on the equipment in such environments.



Danger!

Do not store any flammable or explosive materials in equipment area.



Danger!

Do not place the equipment near heat sources or fire sources, such as smoke, candles, heaters, or other heating devices. Overheat may damage the equipment or cause a fire.



Warning!

Install the equipment in an area far away liquids. Do not install it under areas prone to condensation, such as under water pipe and air exhaust vent, or area prone to water leakage, such as air ventilation vents, or feeder windows of the equipment room. Ensure that no liquid enters the equipment to prevent faults or short circuits.



Warning!

To prevent damage or fire due to high temperature, ensure that the ventilation vents or heat dissipation systems are not obstructed or covered by other objects while the equipment is running.



Warning!

Do not install the equipment near areas that may produce interfering gases, such as garbage dumps or chimney outlets.

-
- The installation and usage environment must meet relevant international, the local laws and regulations. The user is obliged to protect the ESS against fire or other hazards.
 - Do not install in low-lying areas. The installation level must be at least 300mm higher than the highest water level in the area.
 - To protect the equipment from wildfires caused by high temperatures in summer, it should be free of vegetation and flammable plants within 3 meters of the surrounding area.
 - Considering safety, the distance between the equipment and residential buildings should be more than 12m, and the distance between the equipment and schools, hospitals and other densely populated buildings should be more than 30.5m. If this safety distance cannot be met, a firewall should be built between the equipment and the building.
 - The safe distance between the equipment and the production building shall comply with local fire codes or standards.
 - Outdoor storage systems should be at least 10 feet away from boundaries, public roads, buildings, flammable materials, hazardous materials, high piles, and other hazards not associated with the grid infrastructure.
 - The equipment should be installed in an environment free from the risk of explosion.
 - During the installation, commissioning, and operation of the energy storage system, comply with the principle: the number of fire extinguishers near each unit is not less than 2.
 - The distance between the exhaust device of the energy storage system and the heating, ventilation, and air conditioning intakes, windows, doors, discharge platforms, and fire sources of other buildings or facilities shall be more than 4.6m.
 - Reserve enough space for expansion according to the needs of the whole life cycle.
 - Ensure that the equipment is installed in a clean, dry and well ventilated area with proper temperature, humidity, altitude range and so on. Check for more data in the "**Technical Specifications**" section.
 - Do not install energy storage systems in salt-damaged or polluted areas because they may be corroded. Energy storage systems can be used in the following or better environments:

-In a place where is 2000m far away from the coast. It is not recommended to use the energy storage system when it within 500m to 2000m away from the coast . The energy storage system cannot be used when the distance from the coast is less than 500m .

-In a place where the distance from heavy pollution sources, such as smelters, coal mines, thermal power plants, is more than 1500m at least.

-In a place where the distance from moderate pollution sources such as chemical, rubber, and electroplating is more than 1000m at least.

-In a place where the distance from light pollution sources such as food, leather, heating boilers, slaughter houses, centralized garbage dumps, and sewage treatment stations is more than 500m at least.

- Keep the ESS out of the reach of children and away from daily working or living area, including but not limited to the following areas:studio, bedroom, lounge, living room, music room, kitchen,game room, room theater, sunroom,toilet,bathroom,laundry,and attic.
- Do not install the equipment in places without proper fire fighting facilities, or difficult for firefighters to access.
- Do not install the equipment in an easily accessible position because the temperature of the enclosure and heat sink is high when the ESS is running.
- Do not install the ESS on a moving object, such as ship, train, or car.
- Do not install the equipment in an environment with magnetic dust, volatile or corrosive gases, infrared and other radiations, organic solvents, conductive metal,or salty air.
- Do not install the equipment in an area conducive to growth of microorganism such as fungus or mildew.
- Do not install the equipment in an area with strong vibration, noise, or electromagnetic interference.
- Do not install the equipment in an position that may be submerged in water.

3.5.1.3 Foundation requirements

An inadequately constructed foundation can introduce substantial challenges to the installation of Energy Storage Systems (ESS), affecting the smooth operation of doors and the overall functionality of the system. Consequently, the foundation for an ESS must be meticulously designed and constructed in accordance with established standards. This ensures it fulfills the necessary requirements for mechanical support, cable routing, and future maintenance and overhaul operations. During the construction of the foundation, at least the following criteria must be satisfied:

1. **Surface Material:** Install cabinets on concrete or other non-combustible surfaces.
2. **Surface Condition:** Ensure the surface is level, secure, flat, with sufficient load-bearing capacity, and free of depressions or tilts.
3. **Concrete Specifications:** Default to C30 grade concrete with a thickness of 200mm if not specified.
4. **Extension Beyond Cabinet:** Extend each side 300mm beyond the cabinet edges.
5. **Reinforcing Steel Bars:** Use HRB400 (Grade III) steel bars, 12mm diameter, spaced 150mm apart.
6. **Anti-Corrosion Measures:** Apply anti-corrosion treatments to steel bars after rust removal as per standards.
7. **Bedding Layer:** Use a 100mm thick C15 grade bedding layer under the slab.
8. **Bearing Stratum:** Foundation bearing stratum must be undisturbed soil with a characteristic bearing capacity $\geq 100\text{Kpa}$.
9. **Dewatering Measures:** Implement dewatering during construction to prevent waterlogging in the foundation pit.
10. **Excavation Safety:** Ensure proper safety measures for excavation support.
11. **Water Prevention:** After excavation, the foundation pit must not be soaked in water. If disturbed by water, further excavation and replacement filling are required.
12. **Height Requirement:** The foundation must be higher than the local

- historical highest water level and at least 300mm above the ground level.
13. **Drainage System:** Build drainage facilities according to local geology and municipal drainage requirements to ensure no water accumulation occurs at the equipment foundation. It should meet the drainage needs for the largest rainfall in local history. Discharged water from the drainage system must be treated in accordance with local laws and regulations.
 14. **Surface Leveling:** The levelness error between the equipment foundation and the cabinet contact surface must be $\leq 3\text{mm}$.
 15. **Pit Compaction:** The bottom of the equipment foundation pit must be compacted and leveled before proceeding with construction.
 16. **Weight Bearing:** The equipment foundation is configured according to the total weight of the equipment. If the bearing capacity of the foundation does not meet requirements, re-verification is necessary.
 17. **Cable Management:** When building the foundation, consider the cable outlet of the energy storage system and reserve trenches or inlet holes accordingly.
 18. **Sealing:** Both the reserved holes of the equipment foundation and the inlet holes at the bottom of the equipment should be sealed after installation.

Cable Trench Requirements

For energy storage cabinets adopting the bottom cable entry method, a trench must be pre-installed on-site since no side cable inlets are provided to prevent foreign objects from entering. The following requirements apply to the trenches:

1. **Dust-proof and Rodent-proof Design:** To avoid foreign objects entering the energy storage cabinets, the trench must have an effective dust-proof and rodent-proof design.
2. **Waterproof and Moisture-proof Measures:** In order to prevent cable aging and short circuits that could impact the normal operation of the energy storage cabinets, the trench needs waterproof and moisture-proof measures.
3. **Sufficient Cable Bending Radius:** Considering the larger power rating of the energy storage cabinets and the requirement for thicker cables, the

trench design must take into account the cross-sectional area of the cables and provide a sufficient bending radius.

 **Warning!**

The foundation drawing cannot be used as the final construction drawing but only for reference. Users must verify the design parameters of the energy storage system foundation based on the installation environment, ground bearing capacity, geological conditions, and seismic requirements of the project site.

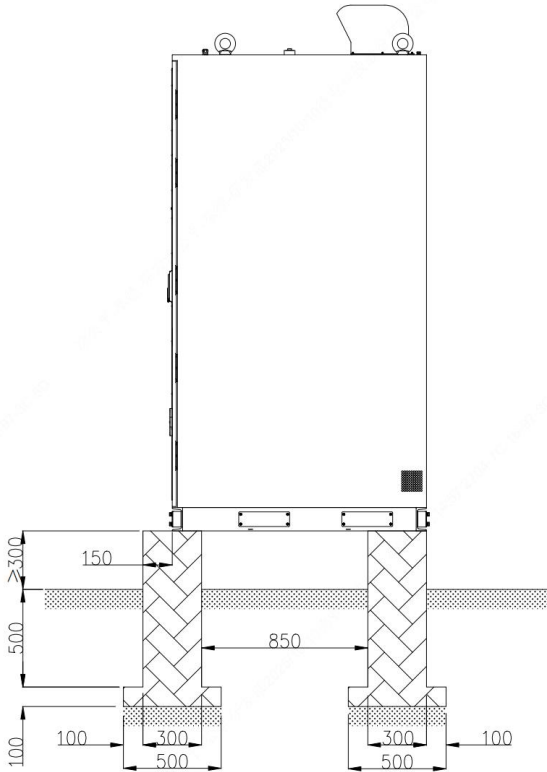

3.5.1.4 Installation clearance requirement

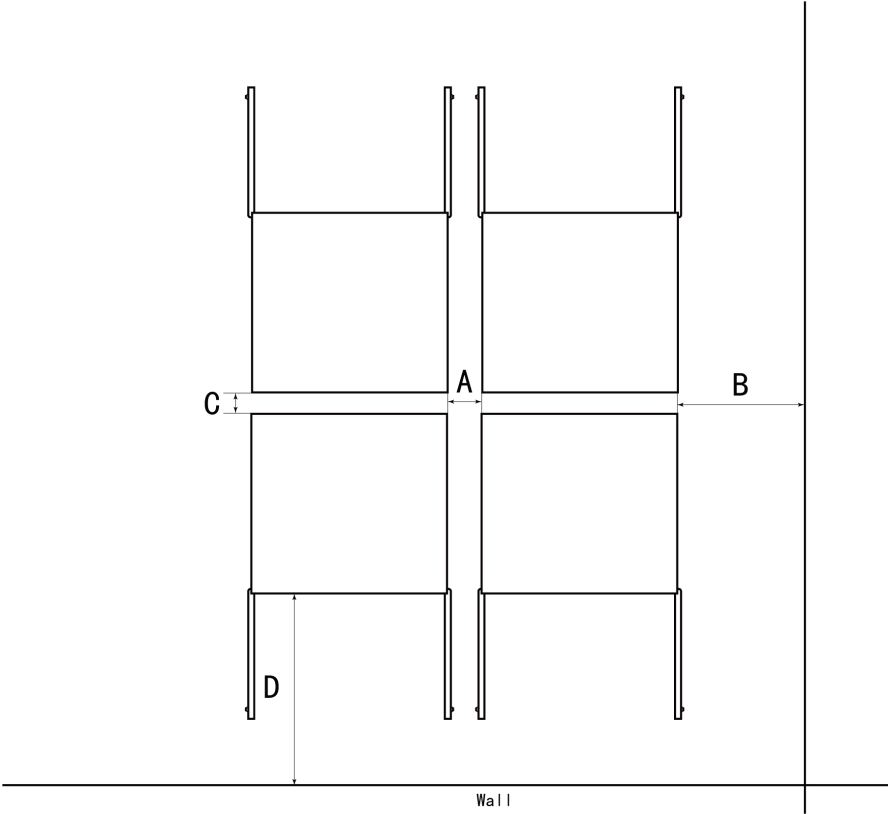

Serial number	Distance (mm)
A	≥ 20
B	≥ 1000
C	≥ 20
D	≥ 3500

3.5.2 Fixing the ESS

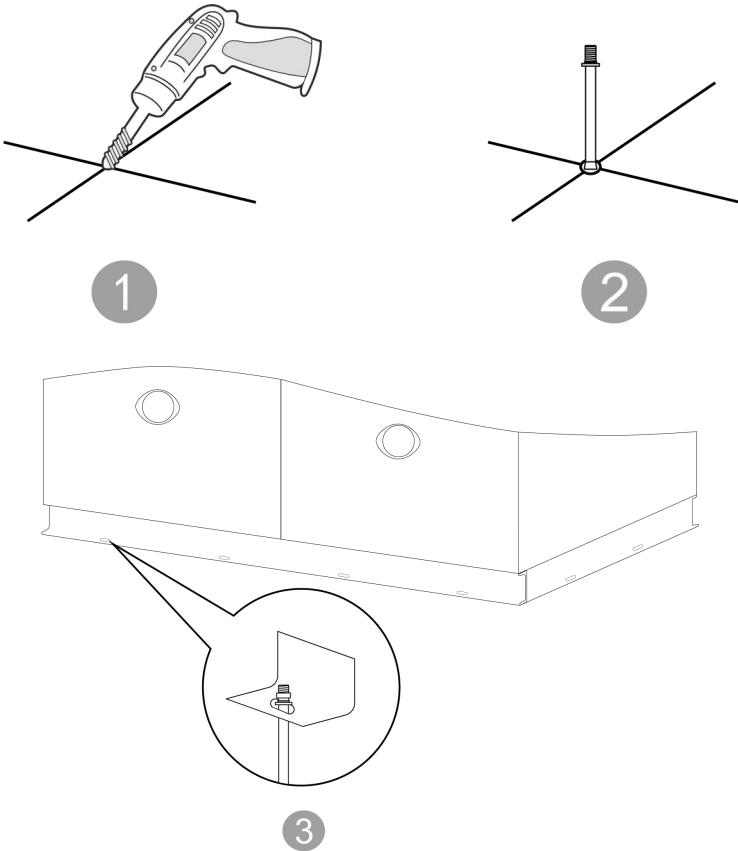

1. Drill holes, with 102-105mm depth, on the ground using an electric hammer. (①)

Pre-install the 8 expansion bolts (M16*150) with 140 N•m. (②)

2. Put the equipment in place and then secure it to the ground by attaching their nuts onto the bolts. (③)



Note!

Due to the uncertainty of drilling accuracy and bit material, it is recommended to choose a drill bit from $\Phi 20.5$ to $\Phi 21$.

3.5.3 Attach the Boards

Making sure that the ESS cabinet has been seated well, you need to attach one board onto every hole for forklift fork insertion, which is used to prevent dust or other foreign objects entering the machine. It is required to secure the boards using M6 bolts with 6N•m.

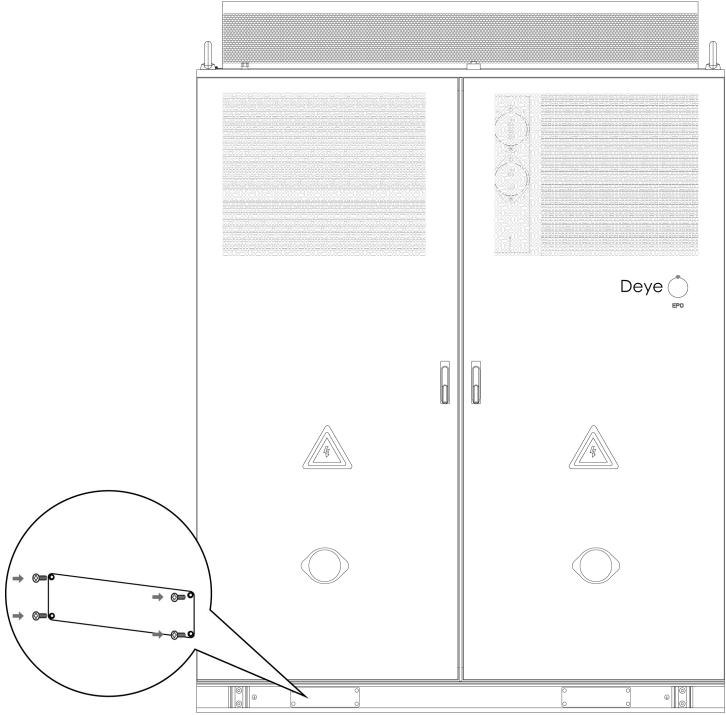

3.5.4 Install the Air outlet

1. Remove the sealing baffle by unscrewing bolts (M5) with 4N•m.

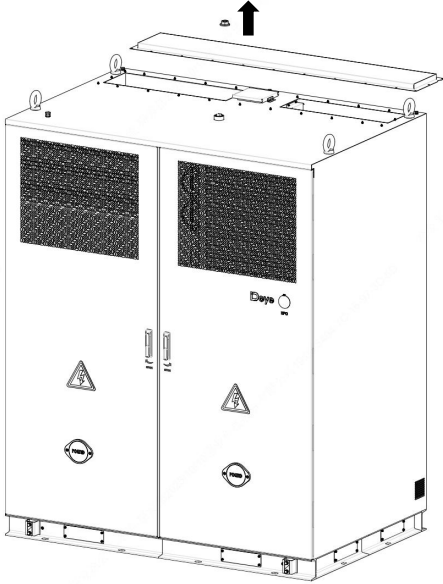

2. Install and fix the air outlet with those bolts (M5).



4 Electrical Connection

4.1 Preparation before Connection



Notice!High voltage! Shock!

- Do not contact live parts directly without protection!
- Before installation, ensure that there is no voltage on the AC side and DC side.
- Do not place the equipment on a flammable surface.



Warning!

- Sand and moisture infiltration can damage the electrical equipment in the container or affect its operating performance!
 - Do not perform electrical connections during sandstorms or when the relative humidity of the surrounding environment is greater than 95%.
 - Make electrical connections when there is no wind or sand and when the weather is clear and dry.
- Before connecting cables, check that the polarity of all input cables is correct. Do not pull wires and cables forcibly during electrical installation.
- Otherwise, the insulation performance may be affected. Make sure all cables and wires have enough room to bend. Take necessary auxiliary measures to reduce the stress on cables and wires.
- After each connection is complete, carefully check whether the connection is correct and secure.

4.1.1 Cable Requirements

When wiring, cables are supposed to meet the following requirements:

- Sufficient current-carrying capacity. Factors that can influence this capacity are shown as follows:
 - environment condition;
 - the type of insulated materials of conductors;
 - cable routing;
 - material and cross-section of cables;
- Suitable diameter and length of cables
- Correct specification and material of cables used for DC input
- Correct specification and material of cables used for AC input
- Only use fire-resistant cables.

How to crimp an OT or DT terminal?

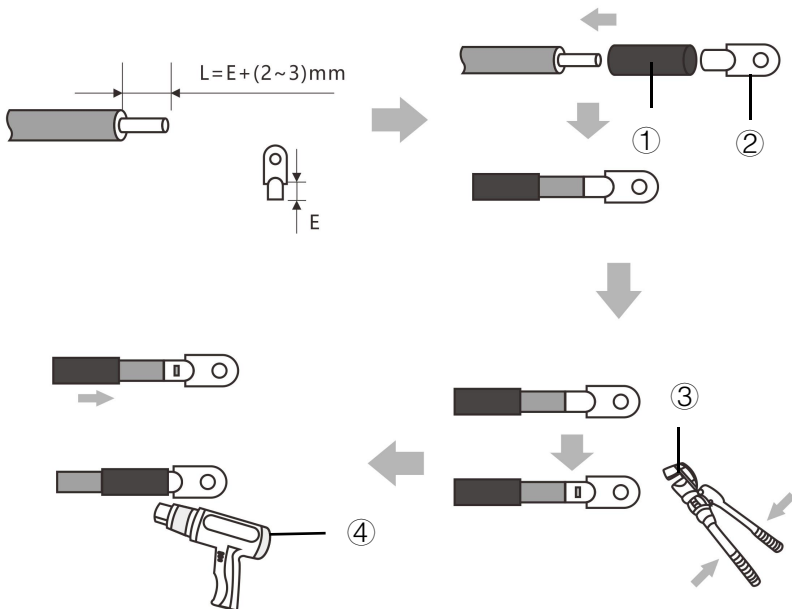

NO.	Description	NO.	Description
①	Hot air duct	③	Hydraulic pliers
②	OT/DT	④	Heat Gun

4.1.2 Opening the Door

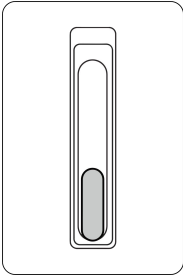

Figure.1

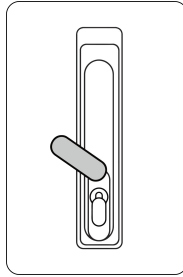

Figure.2

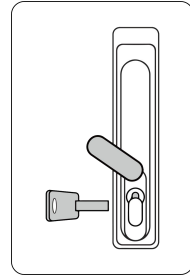

Figure.3

1. The door of the cabinet is in locked state. See the Figure.1
2. Move upward the cover above the keyhole. See the Figure.2
3. Insert the door key and turn it clockwise to eject the handle. See the Figure.3.
4. Rotate the door handle following the direction marked by the indicator arrow on the door to unlock and open the door.

4.2 Cable Connection



Danger!

All electrical connections must be made when the equipment is completely powered off.



Danger!

Note the polarities when installing batteries. Do not connect the positive and negative poles of a battery or battery string together. Otherwise, the battery may be short-circuited.



Danger!

Do not smoke or have an open flame around batteries. Wear personal protective equipment and use dedicated insulated tools to avoid electric shocks or short circuits.



Warning!

- Equipment damage caused by incorrect connections is not covered by the product warranty.
- Only qualified electrical technicians are allowed to connect cables.
- Operation personnel must wear proper PPE when connecting cables.



Warning!

When connecting cables, do not place installation tools, metal parts, or sundries on the ESS. After the connection, clean up objects around the area.



Caution!

- Do not connect two or more cables to the positive or negative power port of a battery in parallel.
- Stay away from the equipment when preparing cables to prevent cable scraps from entering the equipment. Cable scraps may cause sparks and result in personal injury and equipment damage.



Notice!

When connecting to inverters or being in parallel mode, please use cables

provided in the unpacking list. If other cables must be used in special cases, ensure they meet relevant standard.

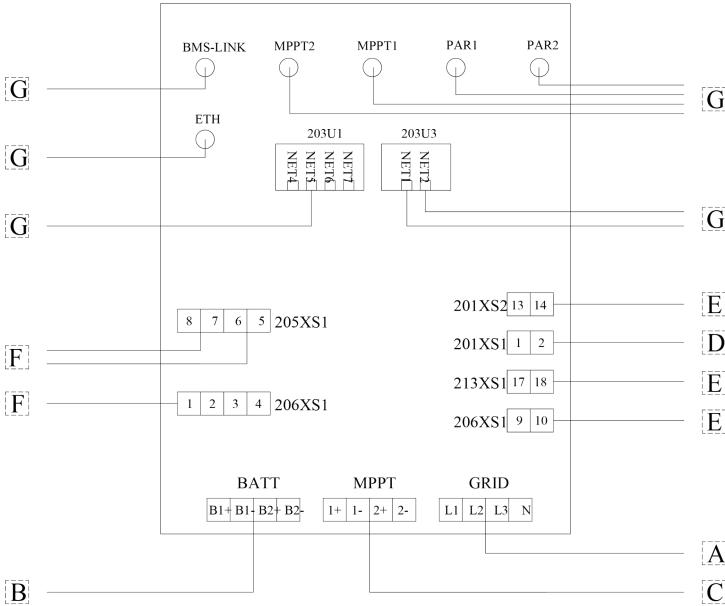

Cable	Recommended size
A	150 mm ²
B	50 mm ²
C	70 mm ²
D	4 mm ²
E	1.5 mm ²
F	0.5 mm ²
G	CAT6 FTP

4.2.1 How to position terminals related?

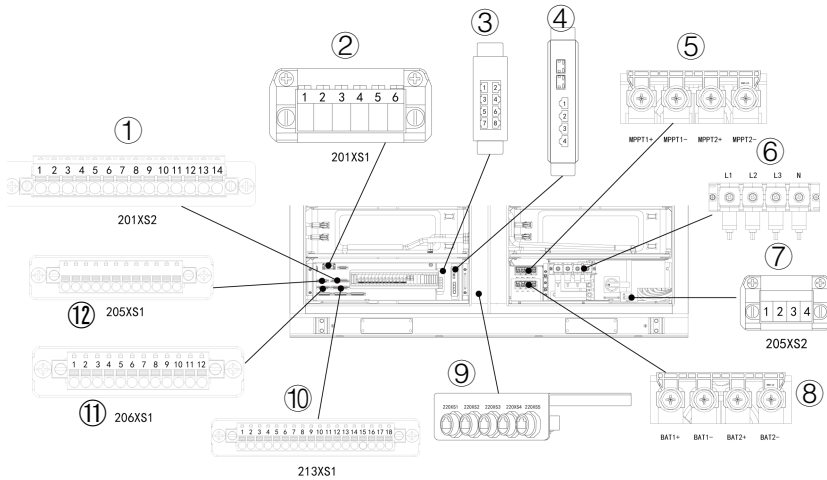

Step	NO.	Port
Step 1: Perform power cable connection	⑤ MPPT	MPPT1+
		MPPT1-
		MPPT2+
		MPPT2-
	⑧ BAT	BAT1+
		BAT1-
		BAT2+
BAT2-		
⑥ GRID	L1	
	L2	
	L3	
	N	
Step 2: Attach to auxiliary power	① 201XS2	13
		14
	② 201XS1	1
		2
⑩ 213XS1	17	
	18	
Step 3: Perform communication cable connection	③ 8-port Switch	NET4
		NET5
		NET6
		NET7
	⑨ Communication Port	220XS1
		220XS2
220XS3		

	④ Ring Network Switch	220XS4
		220XS5
		NET1
		NET2
	⑩205XS1	5
		6
		7
		8
Step 4: Attach to output port	⑪206XS1	1
		2
		3
		4
		9
		10

 **Notice !**

In the energy storage system,MC-L430-2H3, the electricity released by batteries can be supplied to loads.

Terminals 3 and 4 of the ⑦205XS2 port are derived from the 220V AC power output terminal inside this cabinet, and are factory-set to the “self-power supply” mode (Terminals 3 and 4 of ⑦205XS2 are pre-wired to Terminals 1 and 2 of ②201XS1 at the factory).

The terminal 13 of the ①201XS2 is connecting with the L line of external UPS; The terminal 14 of the ①201XS2 is connecting with the N line of external UPS.

4.2.2 Grounding

Warning!

Ensure that the PE cable is securely connected. Otherwise, electric shocks may occur.

Note!

- The PE point at the AC output port is used only as a PE equipotential bonding point and cannot substitute for the PE point on the enclosure.
- It is recommended that silicone grease or paint be applied around the ground terminal after the PE cable is connected.
- After completing the grounding connection, the grounding resistance must be measured. The specific grounding resistance value should comply with the relevant national/local standards and regulations.
- Implementation of either protective earth or auxiliary power grounding is mandatory.

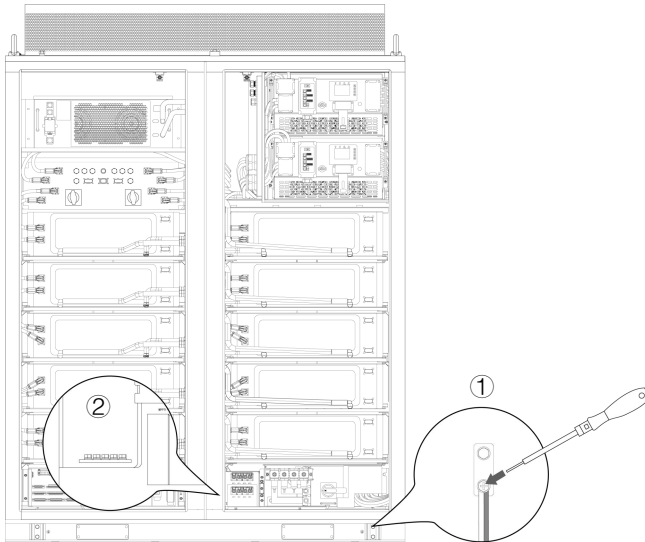

No.	Type	Cable	Section (mm ²)	Terminal	Torque (N•m)
①	Protective earth	Grounding flat steel	150~200	/	
		Grounding cable	50~70	M10 OT/DT terminal	25
②	Auxiliary power grounding	Grounding cable	4	M6 OT terminal	6

4.3 After Connection

Note!

- After wiring, pull out cables slightly to prove that they are connected securely.
- After completing the wire connection, use fire-resistant mud to seal the cable pass-through holes. It is noted that only cable holes through which cables pass need to be sealed with fire-resistant mud.

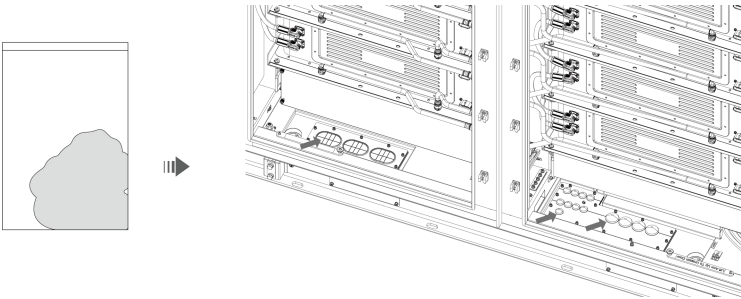

5 Operation Instructions

5.1 Powering on the Equipment

5.1.1 Check Before Power-On

General Check

No.	Check Item	Acceptance Criteria
1	Appearance	<ul style="list-style-type: none">• The equipment is intact and free from rust or paint flake-off. If the paint flakes off, repair the damaged paint.• The labels on the device are clear. Damaged labels must be replaced.
2	Cable appearance	<ul style="list-style-type: none">• Cable sheathings are properly wrapped and not damaged.• Cable hoses are intact.
3	Cable connection	<ul style="list-style-type: none">• Cables are connected in the designed positions.• Terminals are prepared as required and securely connected.• Labels on both ends of each cable are clear and specific, and attached in the same direction.
4	Cable routing	<ul style="list-style-type: none">• Cables are neat and tidy.• Cable tie joints are evenly cut without burrs.• Cables are placed properly and with slack at bending points to avoid stress.• Cables are routed neatly without twists or crossovers in the cabinets.

Cabinet

No.	Check Item	Acceptance Criteria
1	Installation	<ul style="list-style-type: none"> The installation meets the design requirements. The cabinet is level, and each door opens normally.
2	Appearance	<ul style="list-style-type: none"> The cabinet surface is free from cracks, dents, and scratches. If the paint flakes off, repair the damaged paint.
3	Cabinet grounding	<ul style="list-style-type: none"> Ground the cabinet correctly according to the requirements of the power distribution system.
4	Accessory	<ul style="list-style-type: none"> The number and positions of accessories installed meet design requirements.
5	Label	<ul style="list-style-type: none"> All labels are correct, clear, and complete.

Interior

No.	Check Item	Acceptance Criteria
1	Cable	The bolts for installing the cables are tightened and the cables are not loose.
2	Cable hole sealing	Cable holes are sealed.
3	Components	All components are intact.
4	Foreign object	Foreign objects such as tools and remaining materials are cleared.
5	Meter	The meter is free from cracks, dents, and damage, and its buttons are normal.
6	Cabinet grounding	The ground conductor is securely connected to the ground terminal of the cabinet.

5.1.2 Power-On Operations



Danger !

Wear insulated gloves and use insulated tools to prevent electric shocks or short circuits.



Caution !

- During the power-on procedure, monitor the system for faults. If you detect any faults, power off the ESS, rectify the faults, and then continue with the procedure.
- If batteries are fully discharged or over-discharged during system installation and commissioning, charge the batteries promptly to prevent damage due to over-discharge.
- If the ESS has not been used for six months or longer after being installed, it must be checked and tested by professionals before operation. If a circuit breaker in the ESS trips, check the corresponding load side.
- Turn on the circuit breaker only after you have confirmed that there is no short circuit or other fault to prevent the fault from spreading and causing safety risks.



Notice !

Before power-on and long-term operation, remove the desiccants from the ESS and dispose of them according to the applicable local waste disposal act. If the ESS is powered off immediately after being powered on, keep the desiccants in the ESS.

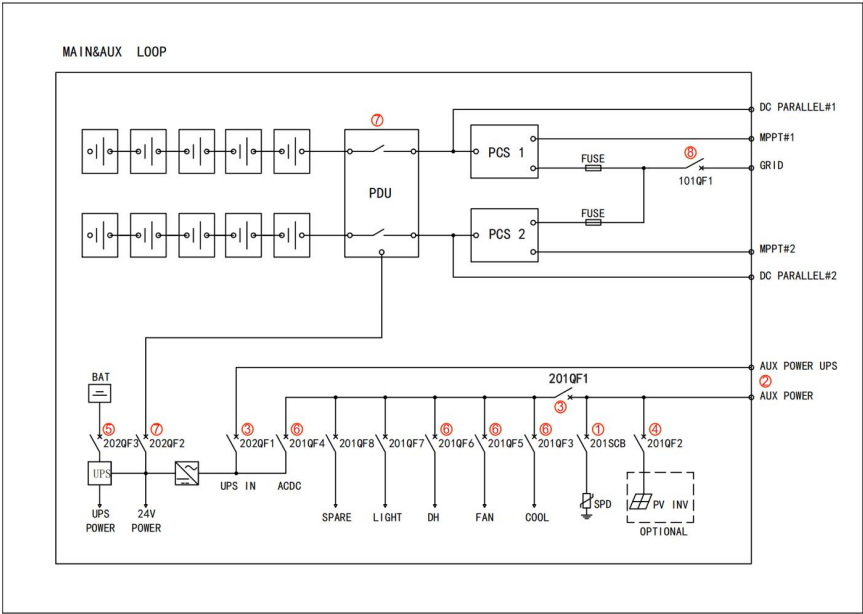

Figure.1

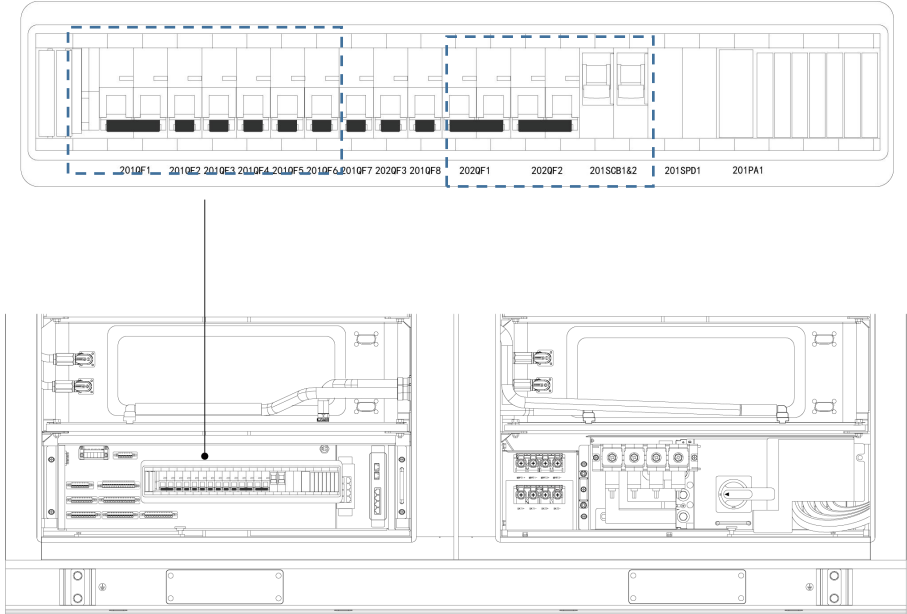

Figure.2

- ① Turn on the surge protection circuit breaker **201SCB1** and **201SCB2**.

See the Figure.2.

- ② Attach to auxiliary power and external UPS. See the “How to position terminals related?”in the section 4.2.1. Verify that both the external AC auxiliary power input and the external UPS AC input voltages are within their specified normal ranges by utilizing a multi-meter.
- ③ Turn on the AC auxiliary power supply breaker **201QF1** and AC UPS breaker **202QF1**. See the Figure.2.
- ④ Turn on the lead-acid battery breaker **202QF3** and perform a vision inspection for the ring network switch by indicators' lighting up.
- ⑤ Turn on the PV power breaker **201QF2** after ensuring the voltage level of the external photovoltaic loop is within the normal range by utilizing a multi-meter. See the Figure.2.
- ⑥ Turn on the liquid cooling system breaker **201QF3**, DC auxiliary power breaker **201QF4**, fan breaker **201QF5** and dehumidifier breaker **201QF6**. See the Figure.2.

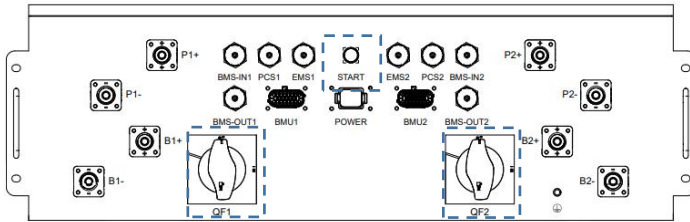

Figure.3

- ⑦ Press the **START** button, turn on the BAT MCCB **QF2** and **QF1** on the DC PDU. See the Figure.3. Measure the 24V DC voltage at the input of 202QF2, and verify the high-voltage box, battery pack power supply, and communication status. If all are normal, turn the DC auxiliary power breaker **202QF2**. See the Figure.2.
- ⑧ Turn on the AC breaker **101 QF1** on the AC PDU. Now the sequence to power on the equipment is finished. See the Figure.4.

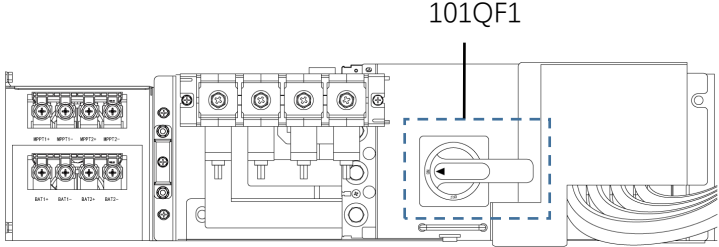
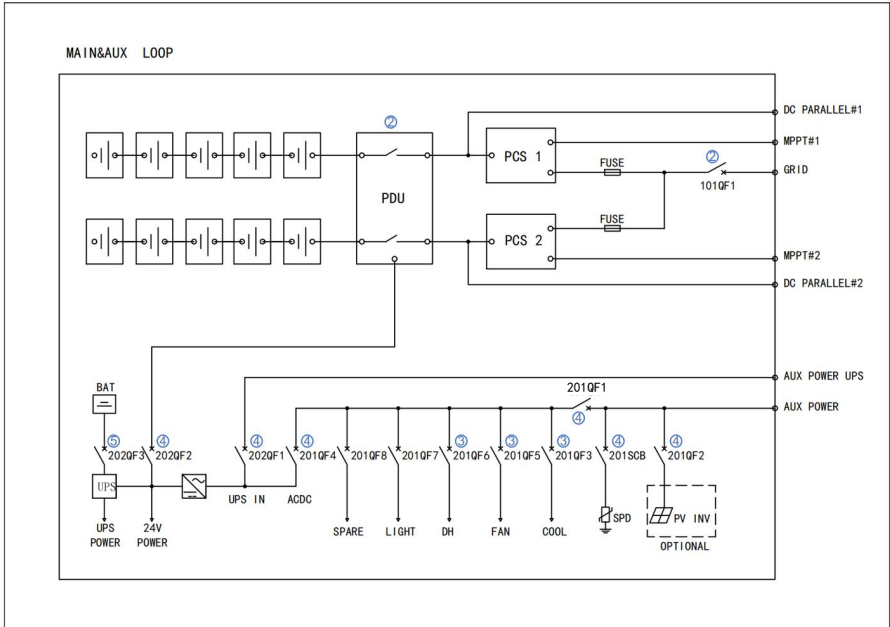

Figure.4

5.2 Powering Off The Equipment

Notice!

Press the emergency stop (EPO) to stop the ESS only in emergency situations.



1. Make sure the entire system is in halt state, in which WEB interface shows system shutdown and PCS display screen shows OFF.
2. Turn off the breaker **QF2** and **QF1** on the DC PDU and then **101QF1** on the AC PDU.
3. Turn off the breaker **201QF3**, **201QF5** and **201QF6**.
4. Turn off the breaker **202QF2**, **202QF1**, **201QF4**, **201QF2**, **201SCB1**, **201SCB2** and **201QF1**.
5. Turn off the breaker **202QF3** and the sequence to power off the equipment is completed.

6 Maintenance

6.1 General Maintenance



Danger!

- Servicing should be performed or supervised by professional personnel.
- Wear personal protective equipment and use dedicated insulated tools to avoid electric shocks or short circuits
- Do not smoke or have an open flame around batteries.
- Do not use wet cloth to clean exposed copper bars or other conductive parts.
- Do not use water or any solvent to clean batteries.
- Charge your equipment in 48 hours after over-discharge.



Warning!

- Do not maintain batteries with power on. Before moving or reconnecting the equipment, disconnect the mains and batteries and wait for five minutes until the equipment powers off. Before maintaining the equipment, check that no hazardous voltages remain in the components to be maintained by using a multi-meters.
- Do not wear jewelry, watches and other metal jewelry when servicing.



Caution!

- Do not connect two or more cables to the positive or negative power port of a battery in parallel.
- Place a warning sign indicating that switch must not be turned on at the position where the switch resides.
- Use a electroscopes of a proper voltage level to check whether the equipment is energized and ensure that the equipment is completely powered off.

-
- Before performing maintenance or repair, securely connect the loop to be repaired to the main ground loop using a ground cable.
 - After the maintenance or repair is complete, remove the ground cable between the loop that has been maintained and the main ground loop.
 - Stay away from the equipment when preparing cables to prevent cable scraps from entering the equipment. Cable scraps may cause sparks and result in personal injury and equipment damage.
 - Cables should be inserted and removed in accordance with regulations. Violent or brute force operations are prohibited.
 - After the maintenance is complete, clean the tools and materials in time, and check whether metal objects remain inside or on the top of the product.
 - When replacing batteries, replace with the same type of spare parts.
 - Do not open or damage batteries. Released electrolyte is harmful to the skin and eyes. It may be toxic.
 - If you have any questions about the operation and maintenance of this product, please contact the customer service center. Do not operate without authorization.

6.2 Maintenance Schedule

6.2.1 Routine Maintenance

Maintenance Category	Maintenance Action	Expected Result
System	Log in to the system management platform (WEB/EMS/APP, etc.) to view system alarm information	● NO primary or secondary alarm info.
Indicator	Check that indicators are in normal state.	<ul style="list-style-type: none">● The indicator stays blue when the system is in standby or discharge state.● The indicator stays green when the system is in charge state.● The indicator stays yellow when the system generates an alarm.● The indicator stays red when the system has a fault and has entered the protection state.
Outside the cabinet	Check that there are any foreign objects wrapped around the cabinet	● The cabinet is never wrapped around or covered by any foreign objects.
Inside the cabinet	Perform an inspection:	● Check that the temperature and

	<ul style="list-style-type: none">● Temperature● Humidity	humidity inside the cabinet are in reasonable ranges.
Battery pack	Perform the visual inspection: <ul style="list-style-type: none">● Temperature and humidity● Run condition	<ul style="list-style-type: none">● Check that there is no obvious damage, paint peeling off, or rust on the appearance.● Check that the temperature and humidity around batteries are in reasonable ranges● Check whether voltage and current are in reasonable ranges when in run.

6.2.2 Quarterly Maintenance

Maintenance Category	Maintenance Action	Expected Result
Safety inspection	Check that EPO and switches to shut off the equipment can work normally	● EPO and switches can work normally
Cabinet	Perform the visual inspection: <ul style="list-style-type: none">● Appearance● Rust condition● Door lock● Vent● Fasteners● Settings	<ul style="list-style-type: none">● There is no obvious paint peeling or rust.● The door locks are not damaged.● There is no dust at the vents.● There are no insects, rodents, snakes or other animals.● All fasteners are secured firmly.● All technical settings can support the normal run of the equipment.
Liquid cooling system	Perform an inspection: <ul style="list-style-type: none">● System operation status● Joints and connections of the liquid cooling pipe	<ul style="list-style-type: none">● Confirm that the temperature and pressure are normal, and both fans and pumps are functioning as expected.● Guarantee that all pipe interfaces are sealed properly with no signs of fluid

		<p>leakage.</p> <ul style="list-style-type: none">● Inspect the liquid cooling system for any unusual noises during operation
PCS	<p>Perform an inspection:</p> <ul style="list-style-type: none">● System operation status	<ul style="list-style-type: none">● Perform cleaning of the fans and heat sinks to maintain optimal thermal management and avoid system overheating● Ensure that all input and output parameters, including voltage, current, and power, remain within specified limits.
Battery pack	<p>Perform the visual inspection:</p> <ul style="list-style-type: none">● Temperature and humidity● Run condition	<ul style="list-style-type: none">● Check that there is no obvious damage, paint peeling off, or rust on the appearance.● Check that the temperature and humidity around batteries are in reasonable ranges● Check whether voltage and current are in reasonable ranges when in run.

6.2.3 Semi-annual Maintenance

Maintenance Category	Maintenance Action	Expected Result
Outside the cabinet	Perform the visual inspection: <ul style="list-style-type: none">● Inflammable materials.	There is no any inflammable objects around the cabinet.
Cabinet	Perform the visual inspection: <ul style="list-style-type: none">● Appearance● Rust condition● Door lock● Vent● Fasteners● Settings	<ul style="list-style-type: none">● There is no obvious paint peeling or rust.● The door locks are not damaged.● There is no dust at the vents.● There are no insects, rodents, snakes or other animals.● All fasteners are secured firmly.● All parameter settings can support the normal run of the equipment.
Cables	<ul style="list-style-type: none">● Check whether cables are securely connected.● Check whether cables are damaged, especially whether the cable sheath that contacts a metal surface is damaged.● Check whether	<ul style="list-style-type: none">● Cables are securely connected.● No damages are found on the cables.● No water enters the equipment and contacts with cables.● There are no insulating tape is peeling off.

	<p>water is entering into the ESS</p> <ul style="list-style-type: none"> ● Check whether any insulating tape on terminals is not detached. ● Check whether all cables are routed correctly. 	<ul style="list-style-type: none"> ● Cable routing is performed correctly and reasonably
<p>Battery pack</p>	<p>Perform the visual inspection:</p> <ul style="list-style-type: none"> ● Appearance ● Rust condition ● Foreign objects ● Fan ● BMS 	<ul style="list-style-type: none"> ● The coating is not peeling or scratched. ● There is no obvious rust. ● There is no foreign objects around the batteries. ● The fan rotates properly without excessive noise. ● Ensure the battery management system (BMS) is functioning properly with no alarms or error messages.
<p>PCS</p>	<p>Perform an inspection:</p> <ul style="list-style-type: none"> ● Electrical connections ● Cooling system ● Operating parameters ● Protective functions ● Operation status 	<ul style="list-style-type: none"> ● Thoroughly examine all terminal blocks for looseness, corrosion, or abnormal heating, ensuring all electrical connections are tight and reliable. ● Perform routine cleaning of fans and heat sinks to maintain effective thermal

		<p>dissipation and avoid system overheating.</p> <ul style="list-style-type: none"> ● Validate key operational parameters such as input/output voltage, current, and power to ensure they remain within specified limits. ● Test and confirm the functionality of critical protection mechanisms against overload, over-voltage, and over-temperature conditions. ● Assess the PCS' status to ensure it is free from fault alarms and operates stably under all conditions.
<p>Protective components</p>	<p>Perform an inspection:</p> <ul style="list-style-type: none"> ● Smoke detector and heat detector ● Water detector ● SPD <p>Perform an zeroing:</p> <ul style="list-style-type: none"> ● Gas detector 	<ul style="list-style-type: none"> ● Confirm the operational status of smoke and heat detectors, as well as the ability of the ventilation fan to start correctly. ● Conduct a drip test to ensure the water sensor alarms appropriately. ● Validate the integrity and

		functionality of surge protection devices and fuses ● Ensure that the gas detector has no zero drift.
--	--	--

6.2.4 Annual Maintenance

Maintenance Category	Maintenance Action	Expected Result
Outside the cabinet	Perform the visual inspection: <ul style="list-style-type: none">● Inflammable materials.	There is no any inflammable objects around the cabinet.
Cabinet	Perform the visual inspection: <ul style="list-style-type: none">● Appearance● Rust condition● Door lock● Vent● Fasteners● Settings	<ul style="list-style-type: none">● There is no obvious paint peeling or rust.● The door locks are not damaged.● There is no dust at the vents.● There are no insects, rodents, snakes or other animals.● All fasteners are secured firmly.● All technical settings can support the normal run of the equipment.
Cables	<ul style="list-style-type: none">● Check whether cables are securely connected.● Check whether cables are damaged, especially whether the cable sheath that contacts a metal surface is damaged.● Check whether water is entering into the ESS● Check whether any	<ul style="list-style-type: none">● Cables are securely connected.● No damages are found on the cables.● No water enters the equipment and contacts with cables.● There are no insulating tape is peeling off.

	<p>insulating tape on terminals is not detached.</p> <ul style="list-style-type: none"> ● Check whether all cables are routed correctly. 	<ul style="list-style-type: none"> ● Cable routing is performed correctly and reasonably
<p>Battery pack</p>	<p>Perform the visual inspection:</p> <ul style="list-style-type: none"> ● Appearance ● Rust condition ● Foreign objects ● Fan ● BMS 	<ul style="list-style-type: none"> ● The coating is not peeling or scratched. ● There is no obvious rust. ● There is no foreign objects around the batteries. ● The fan rotates properly without excessive noise. ● Ensure the battery management system (BMS) is functioning properly with no alarms or error messages.
<p>PCS</p>	<p>Perform an inspection:</p> <ul style="list-style-type: none"> ● Electrical connections ● Cooling system ● Operating parameters ● Protective functions ● Operation status 	<ul style="list-style-type: none"> ● Thoroughly examine all terminal blocks for looseness, corrosion, or abnormal heating, ensuring all electrical connections are tight and reliable. ● Perform routine cleaning of fans and heat sinks to maintain effective thermal dissipation and avoid system overheating. ● Validate key

		<p>operational parameters such as input/output voltage, current, and power to ensure they remain within specified limits.</p> <ul style="list-style-type: none">● Test and confirm the functionality of critical protection mechanisms against overload, over-voltage, and over-temperature conditions.● Assess the PCS' status to ensure it is free from fault alarms and operates stably under all conditions.
Protective components	<p>Perform an inspection:</p> <ul style="list-style-type: none">●Smoke detector and heat detector●Water detector●SPD <p>Perform a calibration and test the device's functions as well as the interlocking system (A gas calibration tool is required, which is not included in the energy storage cabinet):</p> <ul style="list-style-type: none">●Gas detector	<ul style="list-style-type: none">●Confirm the operational status of smoke and heat detectors, as well as the ability of the ventilation fan to start correctly.●Conduct a drip test to ensure the water sensor alarms appropriately.●Validate the integrity and functionality of surge protection devices and fuses

		<ul style="list-style-type: none">● Ensure that the gas detector is functioning properly.
Alert labels	<ul style="list-style-type: none">● Check the warning labels.	<ul style="list-style-type: none">● All warning labels are visible, and no damages or stains on them.
Fire-resistant mud/Foundation	Perform an inspection: <ul style="list-style-type: none">● Fire-resistant mud● Foundation	<ul style="list-style-type: none">● The fire-resistant mud exhibits excellent adhesion.● The foundation is intact with a smooth surface

7 Fire suppression system

7.1 Heat detector

The heat detector monitors temperature and provides a voltage output proportional to the external air temperature by using either a dual thermistor network. One thermistor is exposed to give good thermal contact with the surrounding air while the other thermistor is thermally insulated. Under normal conditions, the indicator light flashes red; when an abnormality is detected, the indicator light remains steadily red.

- Ideal for environments that are dirty or smoky under normal circumstances
- Wide operating voltage.

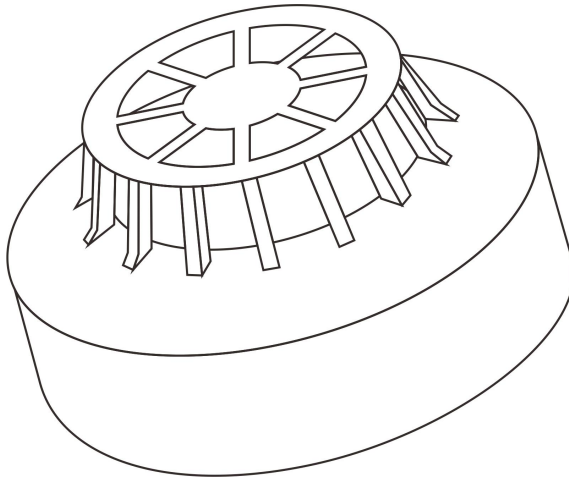

7.2 Smoke Detector

The smoke detector uses the scattered light principle to detect smoke entering the chamber located within the detector housing.

- Responds well to slow burning, smouldering fires
- Unaffected by wind or atmospheric pressure
- Flashing LED and magnet operated test switch option on selected detectors.
- Alarm indicator: Clear light emitting diode (LED) emitting red light

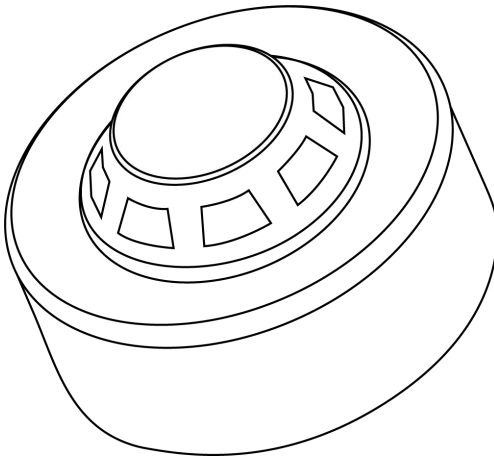

7.3 Gas Detector

The sensors are used to accurately measure carbon monoxide, hydrogen and combustible gas concentrations in the environment. This module adopts RS485 mode output and alarm point output, which is convenient for users to use and has good consistency and stability.

- Long life
- High stability
- High precision and sensitivity
- Modular design and easy maintenance

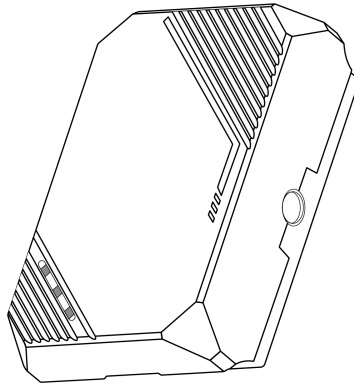

7.4 Fire Suppression System

7.4.1 Aerosol Fire Suppression Device

This is a aerosol extinguishing device. When a fire occurs, the fire extinguishing device ignites the thermal line after receiving the electric start signal or the open fire, and the electric initiator or thermal line burns and activates the aerosol generator in the fire extinguishing device. The aerosol generator decomposes the chemical coolant through the heat released by a series of reactions, so that the aerosol generator and the coolant can be combined to fight against the fire.

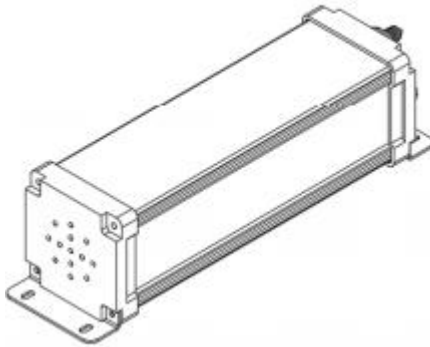

7.4.2 Water Fire Suppression System

Water fire protection is the last protective barrier, opened when all fire protection settings are executed or fail.

In general, it is necessary to ensure that there is no water in the pipeline. It can only be used in case of an emergency.

The water spray extinguishing system should be assembled by your own.

How to install the water pipe?

When installing multiple cabinets, you are advised to install an extension pipe and finally connect the water source (the direction of water supply varies according to customer demand).

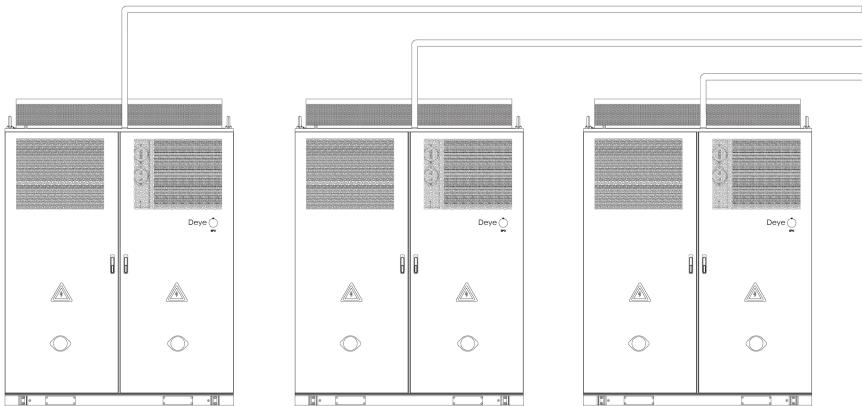

Danger!

If the fire is too violent, flee as soon as possible and call the fire police.

8 Cloud Platform

You can monitor and control your equipment through the cloud platform. After successful login and registration, users can retrieve information about battery packs or the entire system. For detailed instructions on the platform, refer to the user manual by scanning the provided QR code.



9 Troubleshooting

When any error exists in your equipment, please contact the service center or service engineers for help.

10 Repair Paint Damage

10.1 Prerequisites

- Do not apply paint in bad weather, such as rain, snow, strong wind, and sandstorm, when there is no shelter outdoors.
- You have prepared the required paint that matches the color palette delivered with equipment.

10.2 Paint Repair Description

The equipment appearance should be intact. If paint has flaked off, repair paint damage immediately.



Note!

Check the paint damage on the equipment and prepare appropriate tools and materials. The number of materials depends on site requirements.

10.2.1 Paint repair description

Paint Damage	Tool and Material	Procedure	Description
Slight scratch (steel base material not exposed)	Spray paint or paint, brush (required for repainting a small area), fine sandpaper, anhydrous alcohol, cotton cloth, and paint spray gun (required for repainting a large area)	Steps 1, 2, 4, and 5	<ol style="list-style-type: none"> For a few scratches, smudges, or rust, manual paint spraying or brushing is recommended. For many scratches or large-area smudges and rusts, use a paint spray gun. The paint coating should be thin and even. Paint drops are prohibited on the coating. The surface should be smooth. Leave the repainted area for approximately 30 minutes before performing any further operation.
Smudges and rust that cannot be removed			
Deep scratch (primer damaged, steel base material exposed)	Spray paint or paint, zinc-rich primer, brush (required for repainting a small area), fine sandpaper, anhydrous alcohol, cotton cloth, paint spray gun (required for repainting a large area)	Steps 1, 2, 3, 4, and 5	
Logo and pattern damage	If a logo or pattern is damaged, provide the logo size and color number. Seek help from a local supplier of advertisement coatings to formulate a repair solution based		

	on the logo size, color, and damage.	
Dent	<p>If a dent is less than or equal to 100 mm² in area and less than 3 mm in depth, fill the dent with Poly-Putty base and then perform the same operations as those for processing deep scratches.</p> <p>If a dent is greater than 100 mm² in area or greater than 3 mm in depth, ask the local supplier for an appropriate repainting solution.</p>	

10.2.2 Procedure

1. Gently polish damaged areas using fine sandpaper to remove smudges or rust.

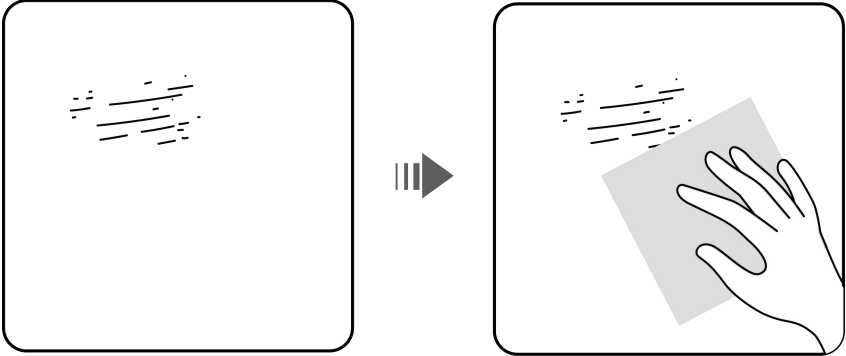

2. Dip a piece of cotton cloth into anhydrous alcohol and wipe the polished or damaged area to remove the dirt and dust. Then wipe off the anhydrous alcohol with a clean and dry cotton cloth.

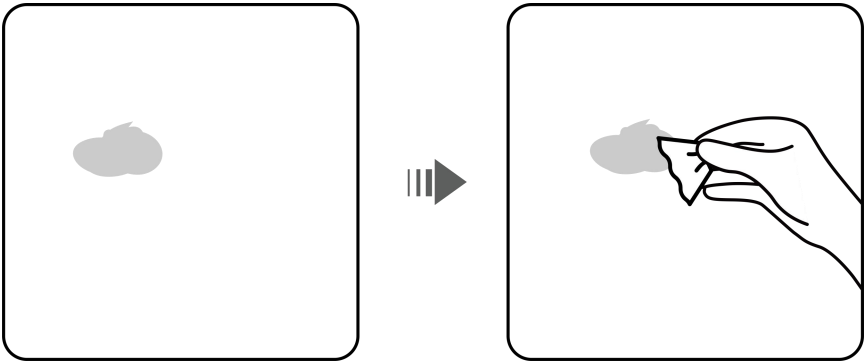

3. Paint zinc-rich primer on the damaged coat using a brush or paint spray gun.

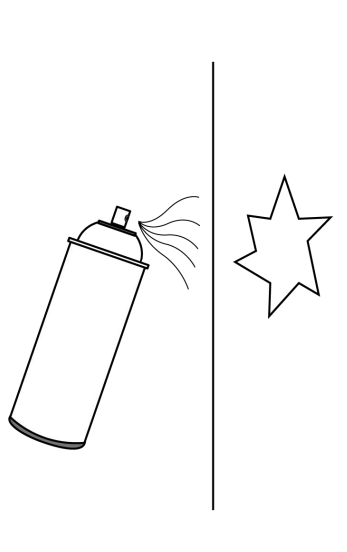

Notice!

- If the base material is exposed in the area to be repaired, apply epoxy zinc-rich primer, wait until the paint has dried, and then apply acrylic acid top coat.
- Select epoxy zinc-rich primer or acrylic acid top coat with a color the same as the surface coating color of the equipment.

4. Apply paint evenly to the damaged area based on the damage degree of the paint using an aerosol spray, brush, or paint spray gun until all damage traces are invisible.



Notice!

- Ensure that the painting is thin, even, and smooth.
- In the case that an equipment pattern has different colors, to prevent undamaged areas and those with different colors as the damaged area from being contaminated during repainting, cover such areas using white paper and adhesive tape before repairing paint.

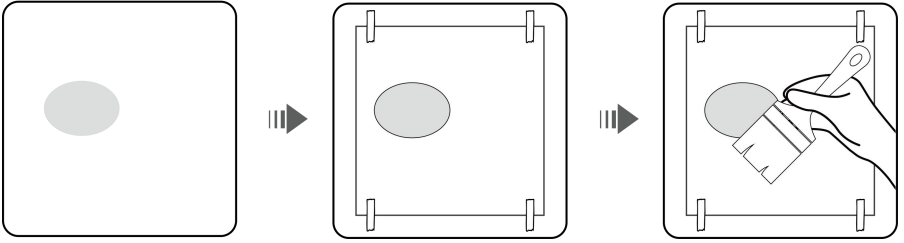

5. Wait for 30 minutes and check whether the painting meets the requirements.



Note!

- The color of the repainted area must be consistent with that of the surrounding area. Make sure that there is no visible edge between the repainted area and the surrounding area. The paint should be free of bulges, scratches, flaking, or cracks.
- If you choose to spray paint, it is recommended that you spray paint three times before checking the result. If the color does not meet the requirements, paint more times until the painting meets the requirements.

11 Emergency Handling

If an accident (including but not limited to the following) occurs on the site, ensure the safety of onsite personnel first and contact the service engineers.

11.1 Battery Falling or Strong Impact

- If a battery has obvious damage or abnormal odor, smoke, or fire occurs, evacuate the personnel immediately, call emergency services, and contact the professionals. The professionals shall use fire extinguishing facilities to extinguish the fire under safety protection.
- If the appearance is not deformed or damaged, and there is no obvious abnormal odor, smoke, or fire, ensure safety and perform the following operations:
 - Warehouse: Evacuate personnel, transfer the battery to an open and safe place by professionals using mechanical tools, and contact the service engineers. Leave the battery for an hour and ensure that the battery temperature is within the room temperature range (tolerance: $\pm 10^{\circ}\text{C}$) before handling.
 - ESS onsite: Evacuate personnel, close the doors of the ESS, transfer the battery to an open and safe place by professionals using mechanical tools, and contact the service engineers. Leave the battery for an hour before handling.

11.2 Flood

- Power off the system if it is safe to do so.
- If any part of the batteries is submerged in water, do not touch the batteries to avoid electric shock.
- Do not use batteries that have been soaked in water. Contact a battery recycling company for disposal.

11.3 Fire



Danger!

- If a fire occurs, power off the system if it is safe to do so.
- Extinguish the fire with carbon dioxide, FM-200 or ABC dry powder fire extinguishers.
- Ask firefighters to avoid contact with high-voltage components during fire fighting to prevent the risk of electric shock.
- Overheating may cause battery deformation, faults, and leakage of corrosive electrolytes or toxic gases. Use respiratory protective equipment and keep a safe distance from the batteries to prevent skin irritation and chemical burns.

11.4 Fire Alarm Horn/Strobe

When the alarm indicator on the equipment blinks or buzzes:

- Do not approach.
- Do not open the door.
- Stay away immediately.
- Cut off the power supply remotely only when your safety is guaranteed.

11.5 Gas Exhaust

- Onsite personal protection: Do not directly face the exhaust vents.
- Post-disaster product maintenance: Contact the service engineers for evaluation.

11.6 Extinguishant Release or Fire

Suggestions for onsite O&M personnel:

- When a fire occurs, evacuate from the building or equipment area, press the fire alarm bell, and immediately call the fire emergency service. Notify the professional firefighters and provide them with relevant product information, including but not limited to battery pack types, ESS capacity, and battery pack location and distribution.
- Do not enter the affected building or equipment area under any circumstances, and do not open the doors of the ESS. Isolate and monitor the site. Keep irrelevant personnel away from the site.
- After calling the fire emergency service, remotely power off the system while ensuring your own safety.
- After professional firefighters arrive, provide relevant product information, including but not limited to battery pack types, ESS capacity, battery pack location and distribution, and user manuals.
- After the fire is extinguished, the site must be handled by professionals in accordance with local laws and regulations. Do not open the doors of the ESS without permission.
- Post-disaster product maintenance: Contact the service engineers for evaluation.

Suggestions for professional firefighters:

- For product information, see the information provided by O&M personnel, including but not limited to battery pack types, ESS capacity, battery pack location and distribution, and user manuals.
- Do not open the doors of the ESS before it is deemed safe by professionals.
- Follow local fire fighting regulations.
- When a fire occurs, prevent the fire from spreading to nearby ESSs.

12 Storage



Note!

- Only trained and qualified personnel are allowed to operate batteries. Wear insulated gloves and use dedicated insulated tools during the operation.
- Do not store battery packs for extended periods. Batteries that have been stored for extended period shall be charged periodically.
Long-term storage of lithium batteries may cause capacity loss.
- The storage environment must comply with local regulations and standards.



12.1 ESS Storage



Storage Requirements

- You are advised to store the ESS in a dry, clean, and ventilated indoor environment that is free from sources of strong infrared or other radiations, organic solvents, corrosive gases, and conductive metal dust. Do not expose the ESS to direct sunlight or rain. Keep the ESS far away from sources of heat and fire.
- Store the ESS separately to avoid mixing with other equipment. The site must be equipped with qualified fire fighting facilities, such as fire sand and fire extinguishers.
- The ESS must be disconnected from external equipment during storage, and the ESS indicators must be off.

Place the ESS correctly according to the signs on the packing case during storage. Do not place the ESS upside down, lay it on one side, or tilt it.

The ESS packaging signs are described as follows.

Name	Symbol	Description
Up		The package shall be kept upright during transportation and storage.
Fragile		The package contains fragile objects and shall be handled with care.
Keep dry		The package shall be protected against rain, and rainproof measures shall be taken during transportation and storage.

Do not roll		The package shall not be rolled during transportation.
Do not stack		The package shall not be stacked.

- Do not unpack an ESS if it will be stored for a long time.
- Do not stack the ESS.
- Ensure that the ground surface is flat (for long-term or temporary storage).
- Refer to the section “Technical Specification” for storage temperature and humidity.
- Close the cabinet door.
- For long-term storage (more than six months after delivery), replace the desiccants with those of the same specifications and amount.
- The storage duration starts from the latest charge time labeled on the ESS packaging. The following table lists the maximum charge intervals. Charge the ESS promptly and calibrate the SOC to 50%. Otherwise, the battery performance and service life may be deteriorated.
- When stored in low SOC, the batteries must be charged within the maximum interval corresponding to the SOC when the batteries are powered off. If the ESS is not charged within the specified interval, the batteries may be damaged due to over-discharge.

- If the ESS has been stored for longer than allowed, promptly report the condition to the person in charge.
- Ensure that the ESSs are delivered on a "first-in, first-out" basis.
- Handle the ESS with care to prevent damage.

12.2 Battery Storage

- Ensure that batteries are stored in a dry, clean, and ventilated indoor environment that is free from sources of strong infrared or other radiations, organic solvents, corrosive gases, and conductive metal dust. Do not expose batteries to direct sunlight or rain and keep them far away from sources of heat and ignition.
- Store batteries in a separate place. Do not store batteries together with other devices. Do not stack batteries too high. The site must be equipped with qualified fire fighting facilities, such as fire sand and fire extinguishers.
- After batteries are powered off, static power consumption and self-discharge loss may occur in internal modules, which may cause battery damage due to over-discharge. Do not store batteries in low SOC and charge batteries in a timely manner.
- The batteries in storage must be disconnected from external devices. The indicators on the batteries must be off.
- If a battery experiences an abnormality such as bulging or smoking during charge, stop charging immediately and dispose of it.
 - If batteries have been stored for longer than allowed, promptly report the event to the person in charge.
- Ensure that batteries are delivered based on the "first in, first out" rule.
- Handle batteries with caution to avoid damage.
- The storage period of battery is 6 months.

12.3 PCS Storage

When devices are stored as spare parts and will not be put into use immediately, the following storage requirements must be met:

- If devices are unpacked but will not be used immediately, put them back to the original packaging with the desiccant, and seal with tape.
- When temporarily storing devices outdoors, do not stack them on a pallet. Take rainproof measures such as using tarpaulins to protect devices from rain and water.
- Refer to the Technical specification for more information including storage temperature and relative humidity
- Do not remove the packaging. Check the packaging regularly (recommended: once every three months). Replace any packaging that is damaged during storage.
- Do not store devices for more than two years. If devices have been stored for two years or longer, they must be checked and tested by professionals before being put into use.
- To avoid personal injury or device damage, exercise caution when stacking devices to prevent them from falling over.

13 Transport

1. The battery products should be transported after packaging and during the transportation process. Severe vibration, impact, or extrusion should be prevented to prevent sun and rain. It can be transported using vehicles such as cars, trains, and ships.
2. Always check all applicable local, national, and international regulations before transporting a Lithium Iron Phosphate battery.
3. Transporting an end-of-life, damaged, or recalled battery may, in certain cases, be specially limited or prohibited.
4. Transportation and storage service providers must have the certification for dangerous goods operations required by local laws, regulations, and standards.
5. Before transportation, make a compliant and accurate declaration. Ensure that the battery packaging, labels, and markings are intact and there is no abnormal smell, leakage, smoke, or fire. Otherwise, the batteries must not be transported.
6. Exercise caution when moving batteries to prevent bumping and ensure personal safety.
7. Unless otherwise specified, dangerous goods must not be mixed with goods containing food, medicine, animal feed, or their additives in the same vehicle or container, and sharp objects are not allowed in the same vehicle or container.
8. Store batteries in a separate area away from heat sources. Protect batteries from moisture, water, and rain. Stack batteries according to the labels on the packing case. Do not stack batteries more than the allowed stacking layers. Do not place batteries on one side or upside down.
9. When transporting faulty batteries, avoid approaching flammable material storage areas, residential areas, or other densely populated places, such as mass transit facilities or elevators.
10. The transport of the Li-Ion battery falls under hazard class UN3480, class 9. For transport over water, air and land, the battery falls within packaging group P1965 Section I. Use Class 9 Miscellaneous Dangerous Goods and UN Identification labels for transportation of lithium-ion

batteries which are assigned Class 9. Refer to relevant transportation documents.



Miscellaneous Dangerous Goods and UN Identification Label

14 Environmental Disposal

- Used batteries can not be disposed of as household waste. Incorrect disposal may result in pollution or explosion.
 - If damages or leakage happen to the battery, ask for technical supports or contact the qualified recycle body to help deal with batteries.
 - Batteries of end of life need to be disposed of in an environmentally-friendly manner.
 - You are obliged to handle waste batteries, such as removal of privacy on product, and return them to designated or authorized recovery point according to applicable regulations and standards on waste battery disposal.



Attention!

1. Do not dispose of batteries and rechargeable batteries as domestic waste! You are legally obliged to return used batteries and rechargeable batteries.
2. Waste batteries may contain pollutants that can damage the environment or your health if improperly stored or handled.
3. Batteries also contain iron, lithium and other important raw materials, which can be recycled.

For more information, please visit <http://www.deyeess.com>. Do not dispose of batteries as household waste!



15 Technical Specifications

Model	MC-L430-2H3
System parameter	
Operating Temperature	-25°C ~ +55°C
Storage Temperature	-30°C ~ +60°C
Humidity	0 ~ 95%
Type of cooling	Liquid cooling
Fire Suppression	Aerosol, Water
Ingress Protection	IP55 (Battery compartment; Chiller control box); IP65 (PCS)
Anticorrosion grade	C4M (C5M is optional)
Altitude	≤2000m
Communication	RS485, Modbus TCP, DIDO
Noise Level@1m	≤75dBA (70dBA solution is optional)
Weight	≤5000kg
Dimensions (W × D × H)	2000 × 1300 × 2480mm (without air outlet cover)
Active Balancing Function	No
DC Data	
Battery	LiFePO ₄
Nominal Capacity	280Ah
Nominal Energy	430.08kWh
Nominal DC Voltage	768Vd.c.
DC Voltage Range	648V ~ 876V
Charge and discharge rate	0.5P
AC Data	
Nominal AC Voltage	380/400V 3P+N+PE
Rated Frequency	50 / 60Hz
Rated Power	200kW
Maximum Power	220kW (1.1 times of rated power)
Power Factor	-1 ~ 1

16 EU Declaration of Conformity



NINGBO DEYE ESS TECHNOLOGY CO., LTD. confirms herewith that the products described in this document are in compliance with the fundamental requirements and other relevant provisions of the above mentioned directives .

		250811048 www.deyeess.com
EU Declaration of Conformity		
Product: Rechargeable Li-Ion Battery Storage System System model: MC-L430-2H3, MC-L430-BC-3 Name and address of the manufacturer: NINGBO DEYE ESS TECHNOLOGY CO., LTD. No.568, South Rixian Road, Binhai Economic Development Zone, Cixi, Ningbo, Zhejiang, P.R.China		
This declaration of conformity is issued under the sole responsibility of the manufacturer. Also this product is under manufacturer's warranty. This declaration of conformity is not valid any longer: if the product is modified, supplemented or changed in any other way, as well as in case the product is used or installed improperly.		
The object of the declaration described above is in conformity with the relevant Union harmonization legislation: The Electromagnetic Compatibility (EMC) Directive 2014/30/EU; the Low Voltage Directive (LVD) 2014/35/EU. References to the relevant harmonized standards used or references to the other technical specifications in relation to which conformity is declared:		
EMC:		
EN IEC 61000-6-1:2019		●
EN IEC 61000-6-3:2021		●
LVD:		
EN 62477-1:2012+A11+A1+A12		●
Nom et Titre / Name and Title:		KunLei Yu <i>KunLei Yu</i> Test Manager
Au nom de / On behalf of:		NINGBO DEYE ESS TECHNOLOGY CO., LTD. 2025-8-11 宁波德业储能科技有限公司 Ningbo, China NINGBO DEYE ESS TECHNOLOGY CO.,LTD
Date / Date (yyyy-mm-dd):		
A / Place :		
EU dXc-v7		NINGBO DEYE ESS TECHNOLOGY CO., LTD No.568, South Rixian Road, Binhai Economic Development Zone, Cixi, Ningbo, Zhejiang, P.R.China

Annex I-Manufacturer Self Declaration

The electrochemical performance and durability parameters
Product Model: MC-L-Pack43

Parameters	Value	Test method
Rated Capacity	280Ah	Actual measurement@25°C±3°C ①0.5P charge ②rest30min ③0.5P discharge
Capacity Fading	8000 Cycles, fade≤30%	Actual measurement@25°C±3°C ①0.5P charge ②rest30min ③0.5P discharge discharge 90%DOD
Power	21500W	@25°C±3°C charge and discharge@ 20%~80%SOC
Power Fading	10 years,fade≤30%	/
Internal Resistance	≤0.01Ω	Actual measurement @25°C±3°C ①0.5P 3.65V, Cut ②Discharge to 50%SOC,rest 3h, V0 ③discharge 1C,10s, V1 ④(V0-V1)/280
Increased internal Resistance	10 years,Increase≤30%	/
Energy efficiency	95%	Actual measurement @25°C±3°C ①0.5P CC 3.65V ②Discharge to 2.5V, E0 ③0.5P charge 3.65V, E1 ④E0/E1
Energy efficiency Fading	10 years,fade≤3%	/
Cycle Life	≥8000@70%SOH, 10 years	Actual measurement@25°C±3°C ①0.5P charge ②rest30min ③0.5P discharge, 90%DOD

Service Hotline: +86-0574-86320560

Email: service-ess@deye.com.cn

Website: <http://deyeess.com>

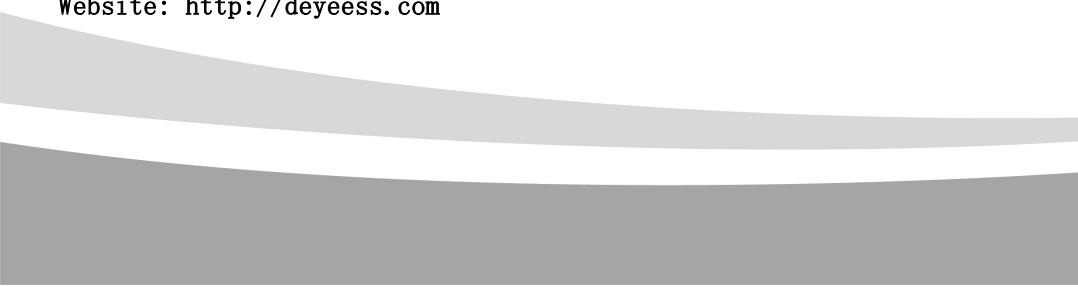
The bottom of the page features decorative wavy lines. A light gray wave starts from the left and curves towards the right. Below it is a white wave, and at the very bottom is a dark gray wave.