

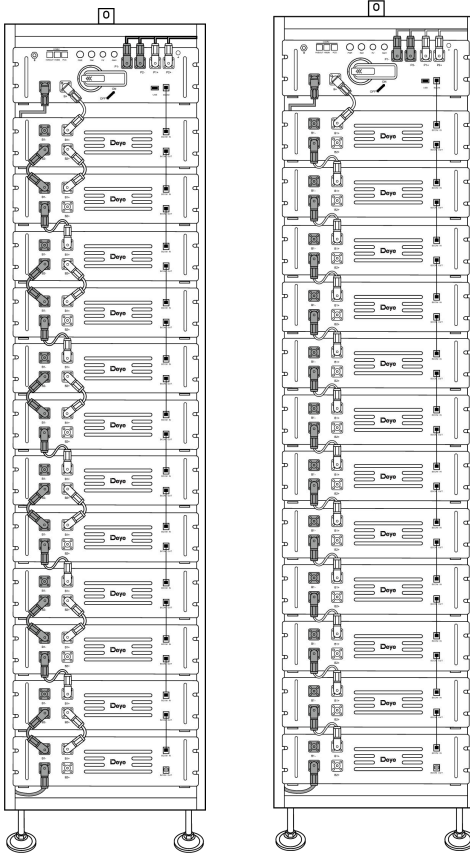

Installation and Operation Instructions

LITHIUM STORAGE SYSTEM



BOS-GS

BOS-GD

Issue: 02
Date: 20250724

Contents

1. Important Information in the Manual	3
1.1 Scope	3
1.2 System Description	3
1.3 Meaning of Symbols	4
1.4 General Safety Information	6
1.5 Disclaimer	6
1.6 Installation Environment	7
1.7 Quality Certificate	8
1.8 Requirements for Installation Personnel	9
2. Safety	10
2.1 Safety Rules	10
2.2 Safety Information	10
3. Transport	12
3.1 Shipment Provisions	12
3.2 Delivery Posture	13
4. Assembly	15
4.1 Installation Precautions	15
4.2 Intended Use	15
4.3 Technical Data	16
4.4 Preparation	17
4.4.1 Tools Required	17
4.4.2 Auxiliary Tools and Materials Required	17
4.5 Description of Rack	18
4.6 Description of Battery Module	19
4.7 Description of HVB	20
4.8 Cable List	21
4.9 Placing Battery Modules into Rack	24
4.10 Cable connection	27
4.10.1 Wiring	27
4.10.2 Grounding description	34
4.11 System startup and shutdown	35
4.12 External 12V Power Supply of HV control box	36
4.13 How to use local mode?	36
5. Troubleshooting	40
6 Maintenance and upgrade	43
6.1 Maintenance	43
6.2 USB's Upgrade Step	44
6.3 PC Upgrade Step	44
6.4 PCS Upgrade Step	48
7. Battery Module Storage	50
8. Disposal	51
9. Appendix	52
9.1 System Circuit diagram	52

1. Important Information in the Manual

1.1 Scope

The installation and operation manual applies to the modular battery energy storage system. Please carefully read this installation and operation manual to ensure the safe installation, preliminary debugging, and maintenance. Installation, preliminary debugging, and maintenance must be carried out by qualified and authorized personnel. Please keep this installation and operation manual and other applicable documents near the battery energy storage system, so that all personnel involved in installation or maintenance can access this installation and operation manual at any time.

This installation and operation manual only applies to countries meeting the certification requirements. Please observe the applicable local laws, regulations, and standards. Standards and legal provisions of other countries may be inconsistent with the provisions and specifications in this manual. In this case, please contact our after-sales service personnel, hotline: +86 0574 8612 0560, email: service-ess@deye.com.cn.

1.2 System Description

Model	System energy (kWh)	Rated DC power (kW)	Discharge depth	Composition
BOS-GS15	15.36	15.36	90%	BOS-G-PACK5.1-4*3+BOS-G-PDU-4*1
BOS-GS20	20.48	20.48	90%	BOS-G-PACK5.1-4*4+BOS-G-PDU-4*1
BOS-GS25	25.6	25.6	90%	BOS-G-PACK5.1-4*5+BOS-G-PDU-4*1
BOS-GS30	30.72	30.72	90%	BOS-G-PACK5.1-4*6+BOS-G-PDU-4*1
BOS-GS35	35.84	35.84	90%	BOS-G-PACK5.1-4*7+BOS-G-PDU-4*1
BOS-GS40	40.96	40.96	90%	BOS-G-PACK5.1-4*8+BOS-G-PDU-4*1
BOS-GS45	46.08	46.08	90%	BOS-G-PACK5.1-4*9+BOS-G-PDU-4*1
BOS-GS50	51.2	51.2	90%	BOS-G-PACK5.1-4*10+BOS-G-PDU-4*1
BOS-GS55	56.32	56.32	90%	BOS-G-PACK5.1-4*11+BOS-G-PDU-4*1
BOS-GS60	61.44	61.44	90%	BOS-G-PACK5.1-4*12+BOS-G-PDU-4*1

Model	System energy (kWh)	Rated DC power (kW)	Discharge depth	Composition
BOS-GD30	30.72	30.72	90%	BOS-G-PACK5.1-4*6+BOS-G-PDU-4*1
BOS-GD40	40.96	40.96	90%	BOS-G-PACK5.1-4*8+BOS-G-PDU-4*1
BOS-GD50	51.2	51.2	90%	BOS-G-PACK5.1-4*10+BOS-G-PDU-4*1
BOS-GD60	61.44	61.44	90%	BOS-G-PACK5.1-4*12+BOS-G-PDU-4*1

1.3 Meaning of Symbols

This manual contains the following types of warnings:



Danger! It may cause an electric shock.

Even when the equipment is disconnected from the power grid, the voltage-free state will have a time lag.



Danger! If the instructions are not observed, death or severe injury may occur.



Warning! If the instructions are not observed, a loss may occur.



Attention! This symbol represents information on the device use.

Symbols on equipment:

The following types of warning, prohibition, and mandatory symbols are also used on the equipment.



Attention! The risk of chemical burns

If the battery is damaged or fails, it may lead to electrolyte leakage, which in turn causes the formation of a small amount of hydrofluoric acid, among other effects. Contact with these liquids can cause chemical burns.

- Do not subject the battery module to severe impact.
- Do not open, disassemble or mechanically change the battery module.
- In case of contact with an electrolyte, wash the affected area with clean water immediately and seek medical advice promptly.



Attention! The risk of explosion

Incorrect operation or fire may cause the lithium-ion battery unit to ignite or explode, leading to serious injury.

- Do not install or operate the battery module in explosive or high-humidity areas.
- Store the battery module in a dry place within the temperature range specified in the data sheet.
- Do not open, drill through or drop the battery cell or module.
- Do not expose the battery cell or module to high temperatures.
- Do not throw the battery cell or module into the fire.
- When the lithium battery catches fire after being plugged in with AC power, unplug the power supply first to prevent electric shock during firefighting.
- If there is an open flame, use carbon dioxide or ABC dry powder fire extinguisher to put out the fire, and then cool down by using the nearby fire hydrant or pouring water until no white smoke appears and the battery is completely cooled down. After extinguishing the fire, continue to monitor the battery for at least 1 hour to prevent re-ignition.
- If there is no open flame but a large amount of white smoke comes out of the battery, it is recommended to use a 6L portable water-based fire extinguisher (if any), and then cool down by using the nearby fire hydrant or pouring water until no white smoke appears and the battery is completely cooled down. After extinguishing the fire, continue to monitor the battery for at least 1 hour to prevent re-ignition.
- Do not use defective or damaged battery modules.



Caution! Hot surface

- If a malfunction occurs, the parts will become very hot, and touching them may cause serious injury.
- If the energy storage system is defective, please shut it down immediately.
- If the fault or defect becomes obvious, special care should be taken when handling the equipment.



No open fire! It is prohibited to handle open flames and ignition sources near the energy storage system.



Do not insert any objects into the opening in the housing of the energy storage system!

No objects, such as screwdrivers, may be inserted through openings in the casing of the storage system.



Wear safety goggles! Wear safety goggles when working on the equipment.



Follow the manual! When working and operating the equipment, the installation and operation manual provisions must be observed.

1.4 General Safety Information



Danger! Failure to comply with the safety information leads to life-threatening situations.

1. Improper use can cause death. Operators of the product must read this manual and observe all safety information.
2. Operators of the product must comply with the specifications in this manual.
3. This manual cannot describe all conceivable situations. For this reason, applicable standards and relevant occupational health and safety regulations are always given priority.
4. In addition, the installation may involve residual hazards in the following circumstances:
 - Incorrect installation.
 - The installation is carried out by personnel who did not receive relevant training or guidance.
 - Failure to observe the warnings and safety information in this manual.

If there are any questions, please contact Deye after service.

1.5 Disclaimer

DEYE ESS TECHNOLOGY CO., LTD shall not be liable for personal injury, property loss, product damage and subsequent losses under the following circumstances.

- Failure to comply with the provisions of this manual.
- Incorrect use of this product.
- Unauthorized or unqualified personnel repair the product, disassembly the rack and perform other operations.
- Use of unapproved spare parts.
- Unauthorized modifications or technical changes to the product.

1.6 Installation Environment

- The battery energy storage system can only be installed and operated in an enclosed space. You can obtain information including environment temperature, humidity and altitude in the section ***“4.4 Technical Data”***.
- The battery module shall not be exposed to a corrosive environment.
- When installing the battery energy storage system, ensure that it stands on a sufficiently dry and flat surface with sufficient bearing capacity.
- In areas where flooding may occur, care must be taken to ensure that the battery module is installed at a suitable height and to prevent its contact with water.
- The battery energy storage system must be installed in a fireproof room. This room must have no fire source and must be equipped with an independent fire alarm device, which complies with local applicable regulations and standards. According to local applicable regulations and standards, the room must be separated by the T60 fire door. Similar fire-proof requirements apply to other openings in the room (such as windows).

Compliance with the specifications in this manual is also part of proper use.

The use of the product is prohibited in the following circumstances:

- Mobile use on land or in the air (use on water only with the manufacturer's consent and with the manufacturer's written consent).
- Used in medical devices.
- Used as a UPS system.

Minimum product installation distance

The minimum distance away from surrounding barriers is 100mm.

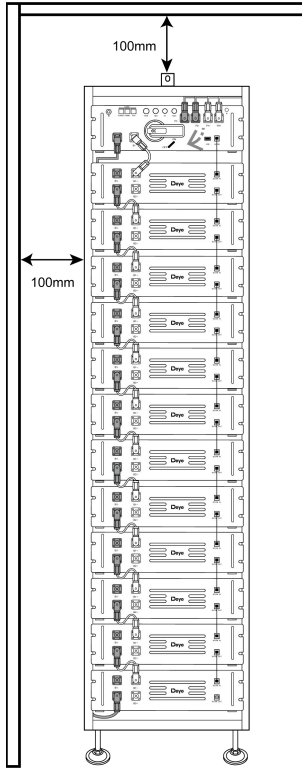

1.7 Quality Certificate

The quality certificate can be downloaded from www.deyeess.com.

1.8 Requirements for Installation Personnel

All work shall comply with local applicable regulations and standards.

The installation of the product can only be completed by electricians with the following qualifications:

- Trained in dealing with hazards and risks associated with the installation and operation of electrical equipment, systems, and batteries.
- Trained on installation and debugging of electrical equipment.
- Understanding and complying with the technical connection conditions, standards, guidelines, regulations, and laws applicable.
- Knowledge of handling lithium-ion batteries (transportation, storage, disposal, hazard source).
- Understanding and complying with this document and other applicable documents.

2. Safety

2.1 Safety Rules

To avoid property damage and personal injury, the following rules shall be followed when working on the hazardous live parts of the battery energy storage system:

- It is available for use.
- Ensure that it will not restart.
- Make sure there is no voltage.
- Grounding protection and short circuit protection
- Cover or shield adjacent live parts.

2.2 Safety Information

Part damage or short circuit may cause electric shock and death. A short circuit can be caused by connecting battery terminals, resulting in current flow. This type of short circuit shall be avoided under any circumstances. For this reason, follow these instructions:

- Use insulated tools and gloves.
- Do not put any tools or metal parts on the battery module or HV control box.
- When operating the battery, be sure to remove watches, rings, and other metal objects.
- Do not install or operate this system in explosive or high-humidity areas.
- When working on the energy storage system, first turn off the charging controller, then the battery, and ensure that they are not turned on again.

Improper use of the battery energy storage system can lead to death. The use of the battery energy storage system beyond its intended use is not allowed, because it may cause great danger.

Improper handling of the battery energy storage system can cause life-threatening risks, serious injury or even death.



Warning! Improper use can cause damage to the battery cell.

- Do not expose the battery module to rain or soak it in liquid.
- Do not expose the battery module to a corrosive environment (such as ammonia and salt).

- The battery energy storage system shall be debugged no later than six months after delivery.

3. Transport

3.1 Shipment Provisions

It is necessary to comply with the relevant regulations and provisions on roads for shipping lithium-ion products in the corresponding countries.



It is prohibited to smoke in the vehicle during transportation or in the vicinity during loading and unloading.



The dangerous goods transport vehicles shall meet relevant regulations concerning road transportation and shall be equipped with fire extinguishers.



It is forbidden for the freight forwarder to open the outer package of the battery module. Use only approved lifting equipment to move the battery system. Use only the hanging lug on the top of the battery rack as the connection point. When lifting, the angle of the sling must be at least 60°.



Improper vehicle transportation can cause injury. Improper transportation or improper transportation locks may cause the load to slip or overturn, resulting in injury. The battery shall be placed vertically to prevent it from sliding in the vehicle, and a fixing belt shall be used.



A tilting of the battery rack may cause injury. When tilted, they may overturn, causing injury and damage. Ensure that the battery module is on a stable surface and that it does not tilt due to load or force.



The battery energy storage system can be damaged, if not properly transported. The battery module can only be transported vertically. Note that these parts may be top-heavy. Failure to follow this instruction may result in damage to the part.



During transportation, the battery storage rack may be damaged when it is installed with the battery module. The battery storage rack is not designed to be transported with the installed battery modules. Always transport the battery module and the battery rack separately. Once the battery module is installed, do not move the battery rack, and do not lift it by a lifting device.



If possible, do not remove the transport packaging before arrival at the installation site. Before removing the transport protector, check if the transport packaging is damaged, and check the impact indicator on the outer packaging of the battery converter. If the impact indicator is triggered, the possibility of transport damage cannot be ruled out.



Improper transportation of battery modules may cause injury. The single battery module is heavy. If it falls or slips, it may cause injury. Only use suitable transport and lifting equipment to ensure safe transport.



Wear safety shoes to avoid the danger of injury. When transporting battery modules, their parts may be crushed due to their heavy weight. Therefore, all persons involved in transportation must wear safety shoes with toe caps. Please observe the safety regulations for transportation at the end customer's site, especially during loading and unloading.



During transportation and installation, the risk of injury increases, especially on sharp metal panels. Therefore, all personnel involved in transportation and installation must wear protective gloves.



A single cluster of battery modules is sufficiently heavy. We suggest that at least 2-3 people work together to install the battery rack. The lifting device is helpful for heavy parts, and the pulley or cart for light parts. Be careful not to damage the case.

Check whether the delivery is complete.

3.2 Delivery Posture

The battery module only can be transported in an upright position. Please note that the battery rack may be very top-heavy.

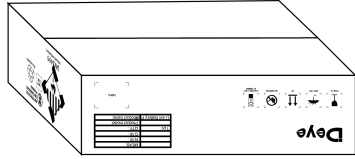
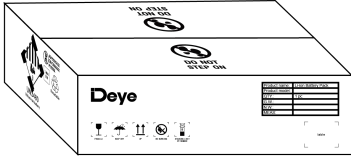

4. Assembly

4.1 Installation Precautions



WARNING! Possible damage to the building due to static overload

1. Ensure that the installation site has sufficient bearing capacity according to total weight of the battery storage system.
2. When selecting the installation site, consider the transportation route and necessary site cleanup.

4.2 Intended Use

The product is a high-voltage lithium-ion battery system. It is characterized by high integration, good reliability, long service life, wide working temperature range, etc. The battery energy storage system is modular. It provides a reliable backup power supply for supermarkets, banks, schools, farms and small factories to smooth the load curve and achieve peak load transfer. It can also improve the stability of renewable systems and promote the application of renewable energy.

4.3 Technical Data



Model		BOS-GS	BOS-GD
Battery cell chemistry		LiFePO4	
Module Energy (kWh)		5.12	
Module Nominal Voltage (V)		51.2	
Module Capacity (Ah)		100	
Battery Module Qty In Series (Optional)		12	6
System Nominal Voltage (V)		614.4	307.2
System Operating Voltage (V)		537.6~700.8	268.8~350.4
System Energy (kWh)		61.44	
System Usable Energy (kWh) ¹		55.29	
Charge/Discharge Current (A) ²	Recommend	50	100
	Nominal	100	100
	Peak Discharge (2 mins, 25°C)	125	125
Working temperature		Charge: 0~55°C/Discharge:-20~55°C	
Status Indicator		Yellow: Battery High Voltage Power On Red: Battery System Alarm	
Communication Port		CAN2.0/ RS485	
Humidity		5% - 85% (RH)	
The altitude of the installation site		≤ 2000 m	
IP Rating of Enclosure		IP20	
Dimensions (W/D/H,mm)		13th floor: 530*602*2219	
Weight Approximate (kg)		610	
Installation Location		Rack Mounting	
Storage Temperature (°C)		0~35	
Recommend Depth of Discharge		90%	
Cycle Life		25±2°C,0.5C/0.5C, EOL70%≥6000	
Certification		UL1973 /UL9540A/UN38.3	

[1] DC Usable Energy, test conditions: 90% DOD, 0.3C charge & discharge at 25° C. System usable energy may vary due to system configuration parameters.

[2] The current is affected by temperature and SOC.

4.4 Preparation

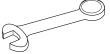
4.4.1 Tools Required

TOOL	PICTOGRAM	USE
PHILIPS# hex wrench		<ul style="list-style-type: none">• Refer to the section "Installation of Rack"
10mm hexagon socket		<ul style="list-style-type: none">• Fix the expansion screw
24mm wrench		<ul style="list-style-type: none">• Adjust the height of the base and tighten the nut.

4.4.2 Auxiliary Tools and Materials Required

AID/MATERIAL Auxiliary tools/materials	USE
Fastening materials (M6*20 screws, M6*100 expansion screws, M6 nuts)	<ol style="list-style-type: none">1. Assemble the battery racks and fix them on the wall or connect the two racks.2. Assemble the battery modules and HV control boxes, and fix them to the racks.

4.5 Description of Rack

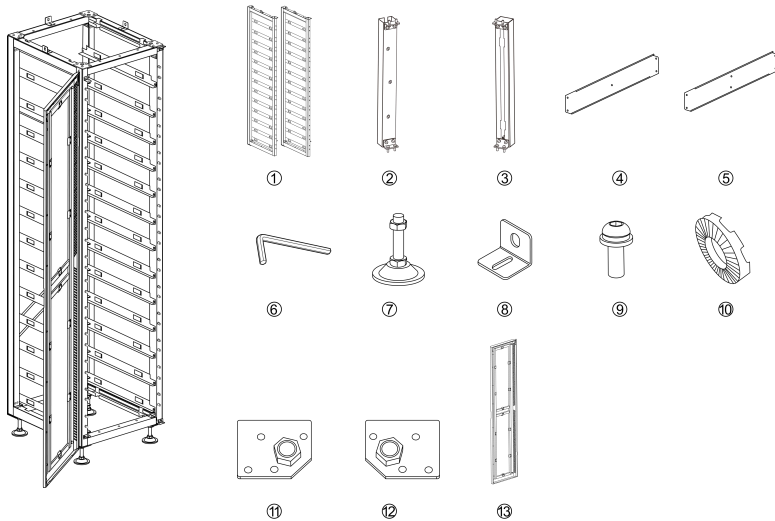

No.	Description	Note
①	Side beam	
②	Bottom beam	
③	Top beam	
④	Lower diagonal brace	
⑤	Upper diagonal brace	
⑥	Allen wrench	
⑦	Adjusting block	
⑧	Rack fastener	
⑨	Round head hexagon screws	
⑩	Broken lacquer flakes	
⑪	Bracket-1	
⑫	Bracket-2	
⑬	Door	Optional, only compatible with some specific racks named in "BOS-A-RackX" and "BOS-G-RackX-3G"(X=9, 13...). Contact your sale representative for more designation info of racks.

4.6 Description of Battery Module

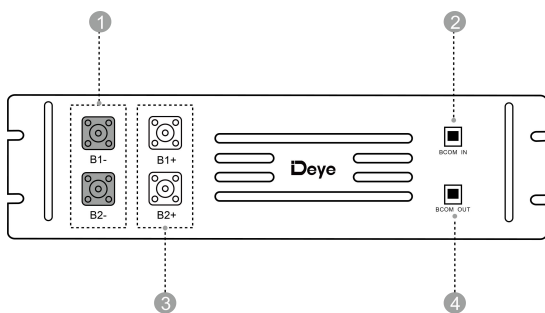

No.	Name	Description
①	B1-/B2-	Battery negative pole (black)
②	BCOM IN	Input terminal of battery communication signals
③	B1+/B2+	Battery positive pole (orange)
④	BCOM OUT	Output terminal of battery communication signals

4.7 Description of High-Voltage Control Box

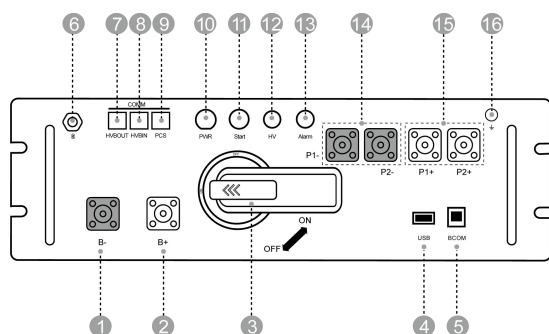

No.	Name	Description	Position
①	B-	Battery negative pole	Front
②	B+	Battery positive pole	Front
③	Circuit breaker	A device used to manually control the entire battery system.	Front
④	USB	BMS upgrade port	Front
⑤	BCOM	Communicative connection with the first battery module	Front
⑥	Bluetooth	Used for Bluetooth connection	Front
⑦	HVBOUT	Connection position with previous HV control box communication input	Front
⑧	HVBIN	Connection position with next HV control box communication output	Front
⑨	PCS COM	PCS COM battery communication terminal: (RJ45 port) follow the CAN protocol (default baud rate: 500bps) and RS485 protocol (default baud rate:9.6bps), used to output battery information to the inverter.	Front
⑩	POWER	Connection position of external 12VDC power supply	Front
⑪	START	A start switch of BMS	Front
⑫	HV light indicator	High-voltage hazard indicator (yellow)	Front
⑬	ALRM light indicator	Battery system fault alarm indicator (red)	Front
⑭	P1-, P2-	Connection position of PCS negative pole (black)	Front
⑮	P1+, P2+	Connection position of PCS positive pole (orange)	Front
⑯	Grounding wire identification	Connection to the battery rack and the ground point	Front

4.8 Cable List

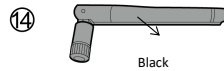
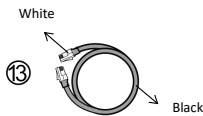
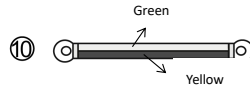
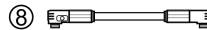
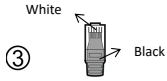
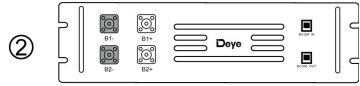
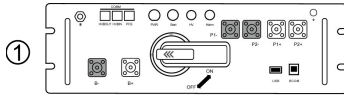

 Color a, negative



 Color b, positive

Note:

1. The definition of the above two colors, a and b, exclude ③, ⑬ and ⑭
2. The color (a) represents black and the color (b) represents red in reality. "Black", "White", "Yellow", and "Green" are colors on items eyed by persons in reality.

No.	Description		Quantity
①	HV control box	Standard	1
②	Battery module	Optional	12
③	Terminal resistor (BMU)	Standard	1
④	HVB communication cable(26AWG 112mm)	Standard	1
	Battery communication cable(26AWG 90mm)		11
⑤	Positive HVB power cord (4AWG 150mm)	Standard	1
⑥	Negative HVB power cord (4AWG 2150mm)	Standard	1
⑦	Negative battery power cord (4AWG 150mm)	Standard	11
⑧	Positive battery power cord (4AWG 150mm)	Standard	6
⑨	Battery power cord (4AWG 150mm)	Standard	6
⑩	Ground wire (10AWG 140mm)	Standard	1
⑪	Positive PCS power cord (6AWG 4000mm)	Standard	2
⑫	Negative PCS power cord (6AWG 4000mm)	Standard	2
⑬	PCS communication cable (26AWG 4000mm)	Standard	1
⑭	Bluetooth wire	Standard	1

Definition of PCS communication interface		Racks in parallel IN		Racks in parallel OUT		Definition of power	
1	485B-	1	BMS_CAN L	1	BMS_CAN L	1	12V
2	485A+	2	BMS_CAN H	2	BMS_CAN H	2	GND
3		3	DI+	3	DO2+		
4	PCANH	4	DI-	4	DO-		
5	PCANL	5		5			
6		6		6			
7	485A+	7		7			
8	485B-	8		8			

Definition of the HV control box interface		Definition of the battery module interface			
Definition of BMS-BMU communication interface		Definition of the upper BMU interface		Definition of the lower BMU interface	
1	BMU_CANL	1	BMU_CANL	1	BMU_CANL
2	BMU_CANH	2	BMU_CANH	2	BMU_CANH
3	DO+	3	DI+	3	DO+
4	DO-	4	DI-	4	DO-
5	GND	5	GND	5	GND
6	GND	6	GND	6	GND
7	12V	7	12V	7	12V
8	12V	8	12V	8	12V



4.9 Placing Battery Modules into Rack



Insufficient or no grounding may cause an electric shock. Device malfunctions, and insufficient or no grounding may cause device damage and life-threatening electric shocks.



Note: Before installing the battery, please turn the circuit breaker of the HV control box to the off position.



CAUTION

Remember that this battery is heavy! Please be careful when lifting out from the module package.



CAUTION

Note the allowable installation modes:



① Install one battery module onto the bottom of battery rack, and then from bottom to the top, continue the installation in the same way till the twelfth battery is seated well. When it comes to thirteenth floor, put the HV control box in place.

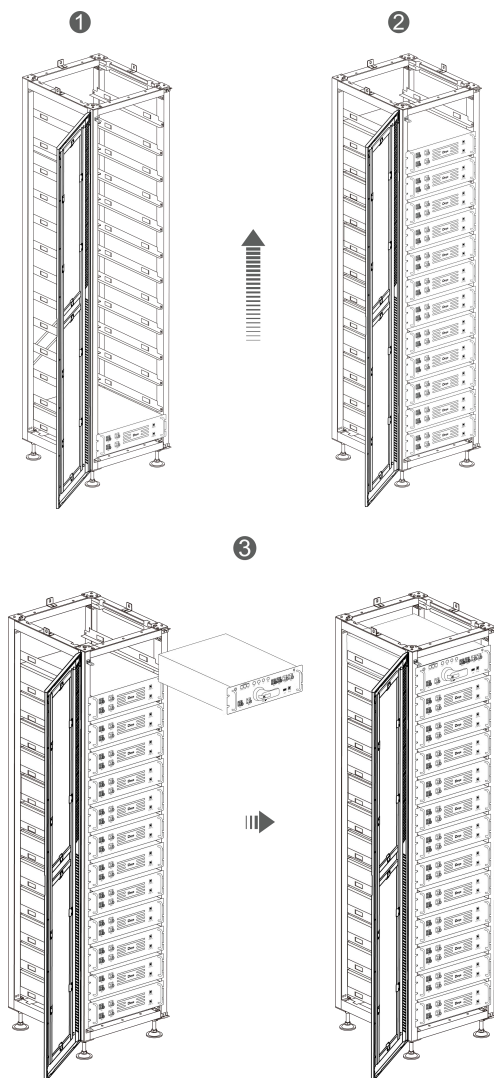

② After battery modules and HV control box are put into the rack, use M6*20 outer hexagon screws to connect all lugs of the battery modules and HV control box to the battery rack.

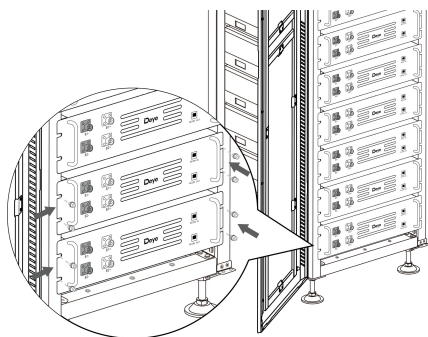

4.10 Cable connection

4.10.1 Wiring

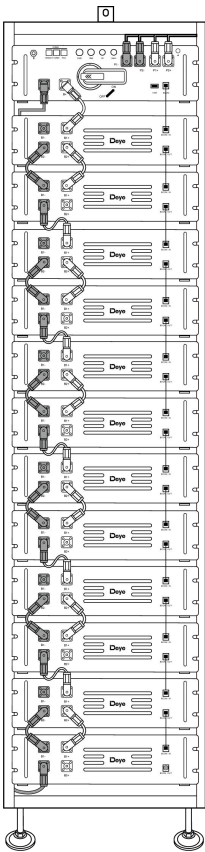

BOS-GS

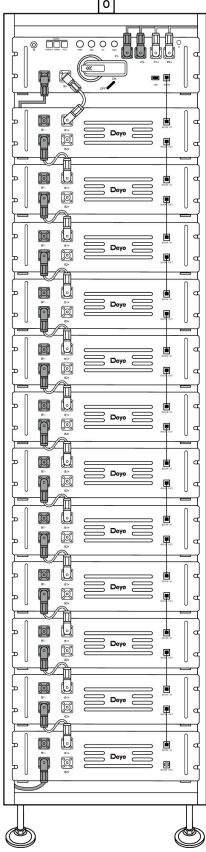

BOS-GD

As shown in the above picture, the difference between the two models mainly lies on the wiring method. BOS-GS is 1P12S and BOS-GD is 2P6S. In the next text, the BOS-GS will be taken as an example to show how to carry out the wire connection. If any difference occurs during illustration, detailed explanation will be made. It is noted that cables mentioned here are listed in the section "4.8 Cable list".

BOS-GS (1P12S):

1. Communication cables: See the figure 1-1 and figure 1-2.

(1) HVBOX-1st battery module, cable④(26AWG 112mm)

HVBOX's BCOM goes into 1st battery module's BCOM IN

(2) Within battery modules, cable④(26AWG 90mm)

Every prior battery module's BCOM OUT goes into the next battery module's BCOM IN.

(3) Last battery module

Last battery module's BCOM OUT is lastly terminated with the 120ohm terminal resistor③ .

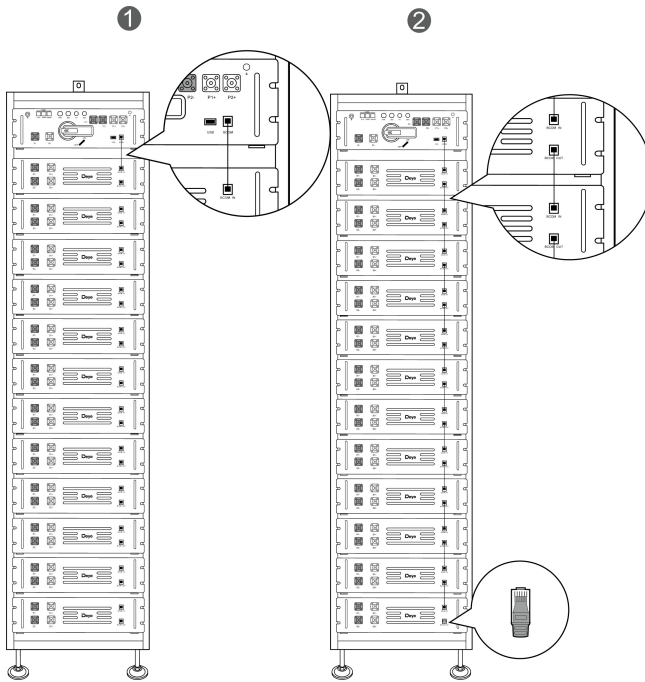

Figure 1-1

Figure 1-2

2. Bcables : See the figure 1-3 and figure 1-4.

(1) HVBOX-1st battery module, cable ⑤

HVBOX's B+ goes into 1st battery module's B1+.

(2) Within battery modules, cable ⑨

Every prior battery module's B2- goes into the next battery module's B1+.

(3) Last battery module, cable ⑥

Last battery module's B2- is lastly connected back to the HVBOX's B-

(4) For aesthetics, it is possible to tuck the last module's B2- to the HVBOX's B- return black Bcable into the back of the rack. Secure the cable to the rack with a zip-tie if necessary.

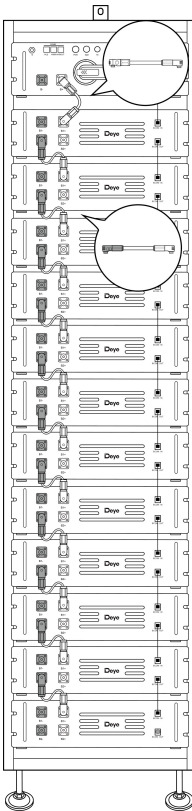

Figure 1-3

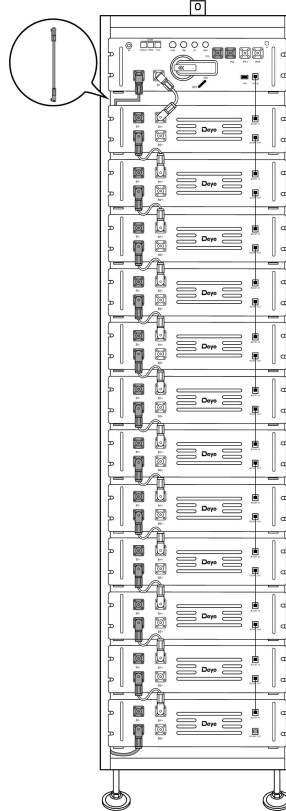

Figure 1-4

3. Attach to the PCS: See the figure 1-5 and figure 1-6.

- (1) HVBOX's PCS goes into PCS's BMS1, cable ⑬.
- (2) HVBOX's P1-&P2- go to PCS's BAT1-&BAT2-, cable ⑫
- (3) HVBOX's P1+&P2+ go to PCS's BAT1+&BAT2+, cable ⑪
- (4) A DC isolation switch is added into between the HV Box and the PCS to control the loop.

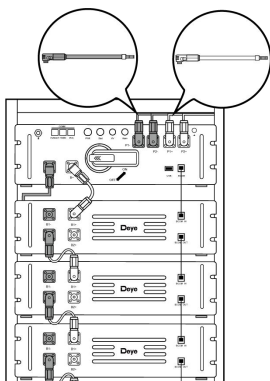

Figure 1-5

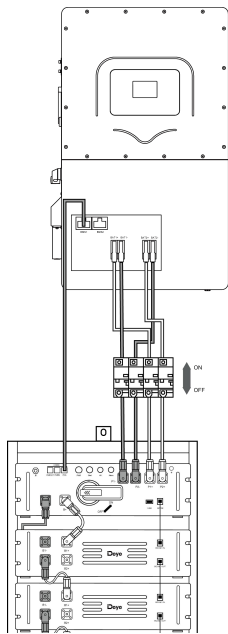

Figure 1-6

BOS-GD (2P6S):

1. Communication cables: See the figure 1-1 and figure 1-2.

(1) HVBOX-1st battery module, cable ④ (26AWG 112mm)

HVBOX's BCOM goes into 1st battery module's BCOM IN

(2) Within battery modules, cable ④ (26AWG 90mm)

Every prior battery module's BCOM OUT goes into the next battery module's BCOM IN.

(3) Last battery module

Last battery module's BCOM OUT is lastly terminated with the 120ohm terminal resistor ③ .

2. Bcables: See the figure 2-1 and figure 2-2.

(1) Battery module groupings

Every two adjacent battery modules are grouped together. From top to bottom, 1st and 2nd modules form group 1, 3rd and 4th modules form group 2, 5th and 6th modules form group 3 and so on. For each group, the upper module's B2- is connected to the lower module's B1- using cable ⑦, and the upper module's B2+ is connected to the lower module's B1+ using cable ⑧.

(2) HVBOX - group 1, cable ⑤

HVBOX's B+ goes into group 1's B1+.

(3) Within battery module groups, cable ⑨

Every prior group's B2- goes into the next group's B1+.

(4) Last battery module, cable ⑥

Last battery module's B2- is lastly connected back to the HVBOX's B-.

(5) For aesthetics, it is possible to tuck the last module's B2- to the HVBOX's B- return black Bcable into the back of the rack. Secure the cable to the rack with a zip-tie if necessary.

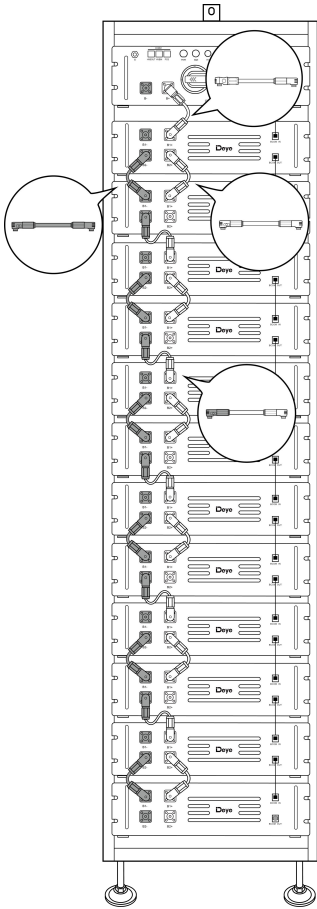

Figure 2-1

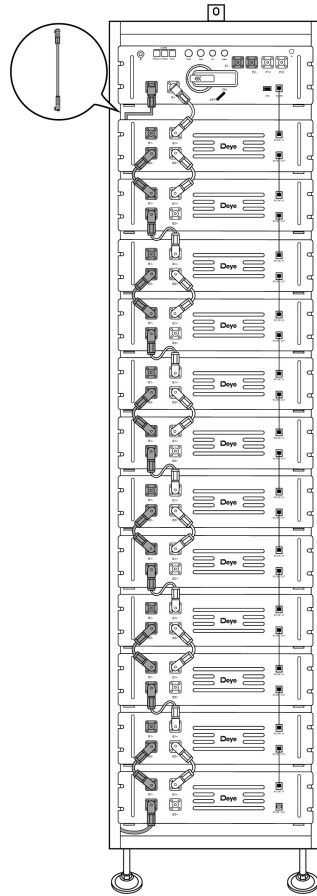

Figure 2-2

3. Attach to the PCS: See the figure 2-3 and figure 2-4.

- (1) HVBOX's PCS goes into PCS's BMS1, cable ⑬.
- (2) HVBOX's P1-&P2- go to PCS's BAT1-&BAT2-, cable ⑫
- (3) HVBOX's P1+&P2+ go to PCS's BAT1+&BAT2+, cable ⑪
- (4) A DC isolation switch is added into between the HV Box and the PCS to control the loop.

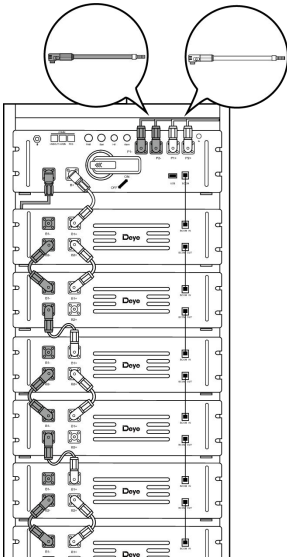

Figure 2-3

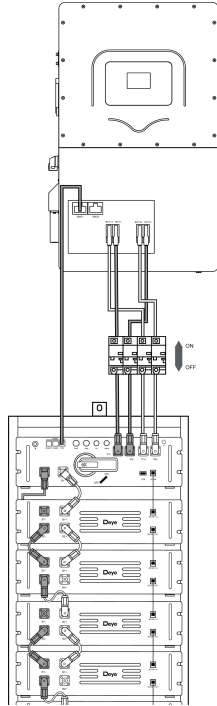
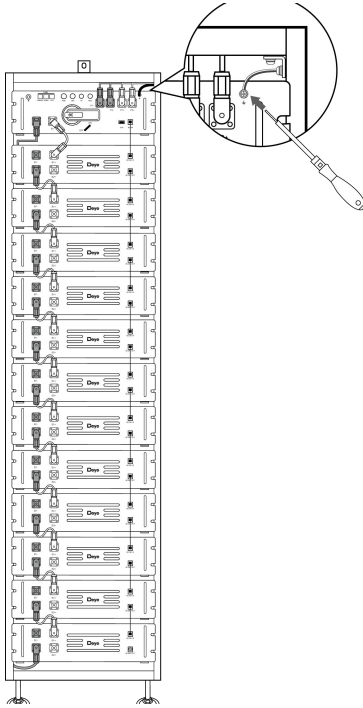

Figure 2-4

4.10.2 Grounding description



Connect one end of the ground wire to the hole reserved for grounding on the HV control box using an M4 screw and the other end to one of holes reserved for grounding on the battery rack using an M6 screw.

4.11 System startup and shutdown

Startup procedure

- ① After making sure all the necessary connections are secured correctly and firmly, turn the circuit breaker handle from “OFF” to “ON” position on the HV control box.
- ② Press the start button.
- ③ Wait for the system to initialize. The start-up sequence is completed when the yellow HV indicator lights up.

Shutdown procedure

- ① Press the start button again .
- ② Wait for the relays within to open (which you can hear) and the yellow HV indicator to go off, after which you can turn the circuit breaker handle from “ON” to “OFF” position.
- ③ The power-off sequence is now completed.

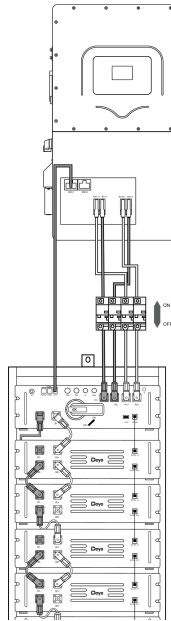

4.12 External 12V Power Supply of HV control box

To operate the HV control box with an external 12V power supply, please contact our service personnel. Hotline: +86 0574 8612 0560, Email: service-ess@deye.com.cn.

In the factory configuration, the HV control box is supplied with working voltage from an internal power supply unit. If your plan requires an external 12V power supply, an adaptive version and a HV control box can be provided as requested. Please contact our after-sales service personnel for details.

4.13 How to use local mode?

Scan the QR code and download the Bluetooth APP. After downloading the APP, please follow the steps below to complete the operation.



Step 1: Log into the APP and select "Local Mode".

Step 2: Select the device type —— Battery BLE.

Battery BLE refers to batteries with Bluetooth function

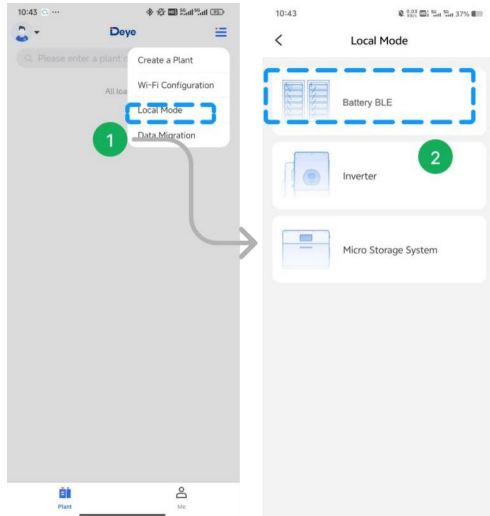

Step 3:Click the “Add a Device”.

Step 4: Searching for nearby device via the Bluetooth, and then select the “BAT”.

Step 5: After the “Pairing complete” shows up, click the “Enter debug mode”to view your data.

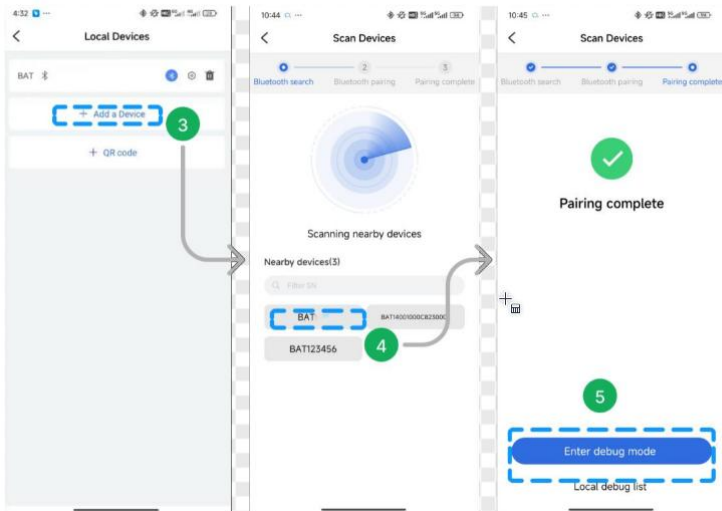

Step 6: Besides using the Bluetooth mode, adding the SN also supports Scanning the QR code or entering the SN code manually.

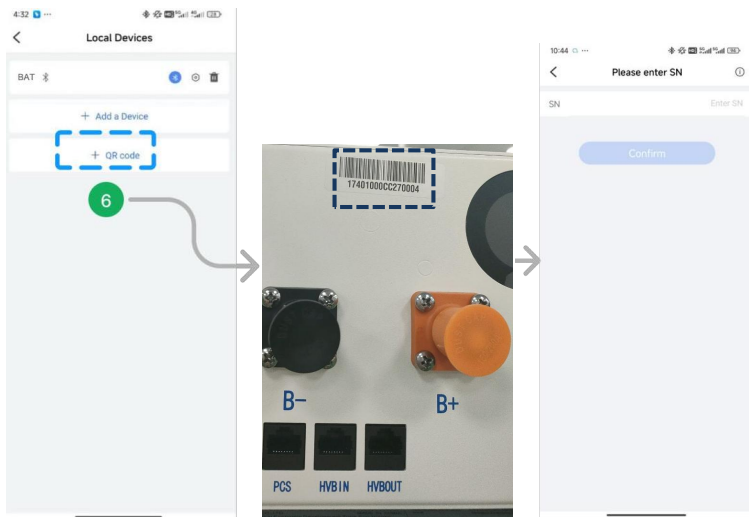

Step 8: Detailed information of the battery could be viewed in the Local Mode, such as BMS, Alarm and BMU etc.

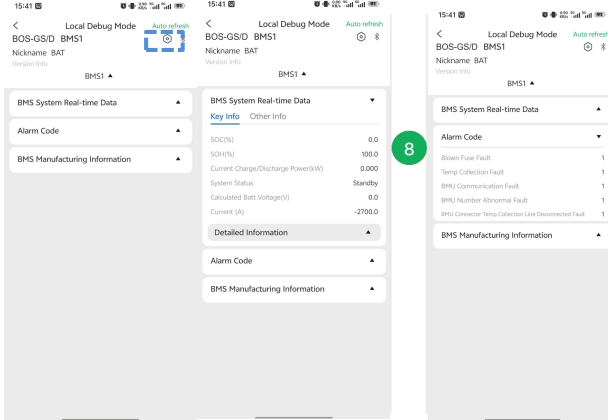

How to personalize the BOS-GS/BOS-GD name?

Step a: Tap on the upper right corner to edit Nickname.

Step b: Input the new name, click the “Confirm” and then the changed name will be displayed on the interface.

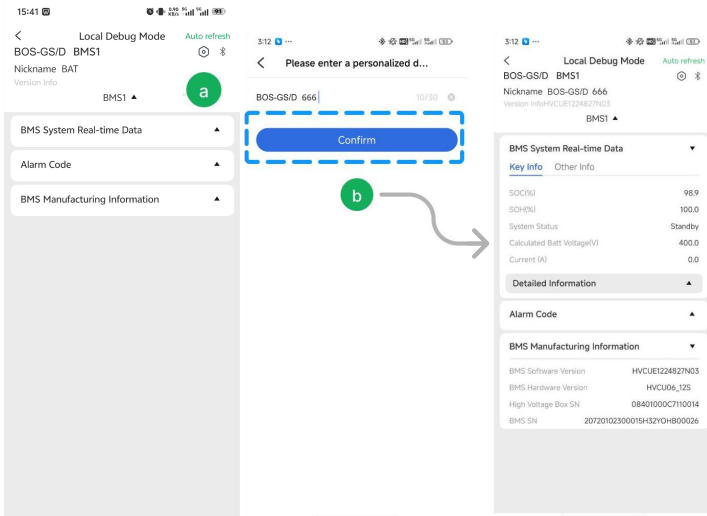

5. Troubleshooting

Different types of faults are below:

	Fault types	Trigger conditions
System faults	Charge over-current alarm	Exceeding the parameter set value and set time (More than 105A, 2s; more than 125A, 5s; more than 140A, 2s; lower than 5°C, set value*0.5)
	Charge over-current protection	
	Discharge over-current alarm	
	Discharge over-current protection	
	Charge overtemperature alarm	Exceeding the parameter set value and set time (>45°C, 2s)
	Charge overtemperature protection	Exceeding the parameter set value and set time (>50°C, 2s)
	Discharge overtemperature alarm	Exceeding the parameter set value and set time (>50°C, 2s)
	Discharge overtemperature protection	Exceeding the parameter set value and set time (>55°C, 2s)
	Charge under temperature alarm	Exceeding the parameter set value and set time (<5°C, 2s)
	Charge under temperature protection	Exceeding the parameter set value and set time (<0°C, 2s)
	Discharge under temperature alarm	Exceeding the parameter set value and set time (<-10°C, 2s)
	Discharge under temperature protection	Exceeding the parameter set value and set time (<-20 °C, 2s)
	Excessive differential voltage alarm	Exceeding the parameter set value and set time (>500mv, 2s)
	Excessive differential voltage protection	Exceeding the parameter set value and set time (>800mv, 2s)
	Excessive differential temperature alarm	Exceeding the parameter set value and set time (>10°C, 2s)
	Excessive differential temperature protection	Exceeding the parameter set value and set time (>15°C, 2s)
	Cell overvoltage alarm	To maintain consistency, cut off the charging immediately when the full charge calibration rated voltage of 3.6V is reached. When the voltage drops to 3.35V, restart it with the turned-off red light indicator. All protective red
	Cell overvoltage protection	
	Cell undervoltage alarm	
	Cell undervoltage protection	

System faults		light indicators are always on!
	Pre-charge resistor overtemperature alarm	Exceeding the parameter set value and set time (>55°C, 2s)
	Pre-charge resistor overtemperature protection	Exceeding the parameter set value and set time (>65°C, 2s)
	Insulation level 1	Exceeding the parameter set value and set time
	Insulation level 2	Exceeding the parameter set value and set time
	Heating film overtemperature alarm	Exceeding the parameter set value and set time (>75°C, 2s)
	Heating film overtemperature protection	Exceeding the parameter set value and set time (>80°C, 2s)
	BMS connector overtemperature alarm	Exceeding the parameter set value and set time
	BMS connector overtemperature protection	Exceeding the parameter set value and set time
	BMU connector overtemperature alarm	Exceeding the parameter set value and set time
	BMU connector overtemperature protection	Exceeding the parameter set value and set time
	Power loop overtemperature alarm	Exceeding the parameter set value and set time
	Power loop overtemperature protection	Exceeding the parameter set value and set time
	SOC too low	Exceeding the parameter set value and set time
	Total voltage too high alarm	Exceeding the parameter set value and set time
	Total voltage too high protection	Exceeding the parameter set value and set time
	Total voltage too low alarm	Exceeding the parameter set value and set time
	Total voltage too low protection	Exceeding the parameter set value and set time
	Discharge relay adhesion	Relay feedback information state adhesion
	Charge relay adhesion	Relay feedback information state adhesion
	Heating relay adhesion	High voltage is detected after disconnecting the heating relay
	Limit protection	Exceeding the parameter set value and set time
	Abnormal power supply	Exceeding the parameter set value and set time

voltage	
Master positive relay adhesion	Relay feedback information state adhesion
Fuse Blown	No high voltage is detected after the loop relay is closed
Repeated BMU address fault	BMU with the same number
INTER-CAN BUS communication failure	Loss of communication between BMS
PCS-CAN BUS communication failure	The heartbeat message of the inverter is not received for a long time
RS485 communication failure	Inverter RS485 access is not received for a long time
Abnormal RS485 communication	C
External total voltage acquisition fault	/
Internal total voltage acquisition fault	The difference between the acquired internal total voltage and the accumulated internal total voltage exceeding the set value
SCHG total voltage acquisition fault	/
Cell voltage acquisition fault	The cell voltage acquired is 0
Temperature acquisition failure	The temperature acquired is -40°C
Current acquisition fault	/
Current module fault	Abnormal Hall current/reference voltage
EEPROM storage failure	EEPROM write failure during self-test
RTC clock fault	The external RTC failed to enable the charging function
Pre-charge failure	Pre-charge timeout
Charging voltage too low	The minimum cell voltage is lower than the set value
BMU lost	BMU message not received for a long time
Abnormal number of BMU	The number of BMU addresses is different from the number of set parameters



Note: For more information, please contact us. Email: service-ess@deye.com.cn, Service Hotline: +86 0574 8612 0560.

6 Maintenance and upgrade



Warning! Improper decommissioning may cause damage to the equipment and/or battery inverter.

Before maintenance, ensure that your equipment is decommissioned according to relevant provisions.



Note: All maintenance work shall comply with local applicable regulations and standards.

The USB disk port of the equipment has the functions of upgrading firmware and recording battery data, which can be used as an auxiliary tool.

6.1 Maintenance

To ensure safe operation, all plug connections must be checked. If necessary, relevant operators shall press them back into place at least once a year.

The following inspection or maintenance must be carried out once a year:

- General visual inspection
- Check all tightened electrical connections. Check the tightening torque according to the values in the following table. Loose connections must be retightened to the specified torque.

Connection mode	Tightening torque
HV control box grounding	1.2N.m
Fixing the lug of the HV control box	4.5N.m
Fixing the lug of the battery module	

- Using the monitoring software, check whether the SoC, SoH, battery voltage and temperature of the battery module are abnormal.
- Shut down and restart the equipment once a year.

Note: If the system is installed in a polluted environment, maintenance and cleaning must be carried out at short intervals.

Note: Clean the battery rack with a dry-cleaning cloth. Ensure that no moisture comes into contact with the battery connections. Do not use solvents.

6.2 USB's Upgrade Step

- ① USB type: USB2.0, FAT32;
- ② Create the upgrade folder according to the directory;
- ③ Place the upgrade file provided by the supplier in the upgrade folder;
- ④ Turn on the battery, and insert the USB flash disk after the blue indicator is on;
- ⑤ After the blue light indicator flashes and turns off, pull out the USB flash disk to complete the upgrade. Do not turn off the battery during the process.
- ⑥ After the blue light indicator of the battery lights up again, check the version number through the screen or app and verify the upgrade result.

6.3 PC Upgrade Step

1. Upgrade all modules

Step 1: After successfully connecting to the upper computer, carry out the operation in the order "Open inter-can bus→ Firmware → Browser→Upgrade File→Open".

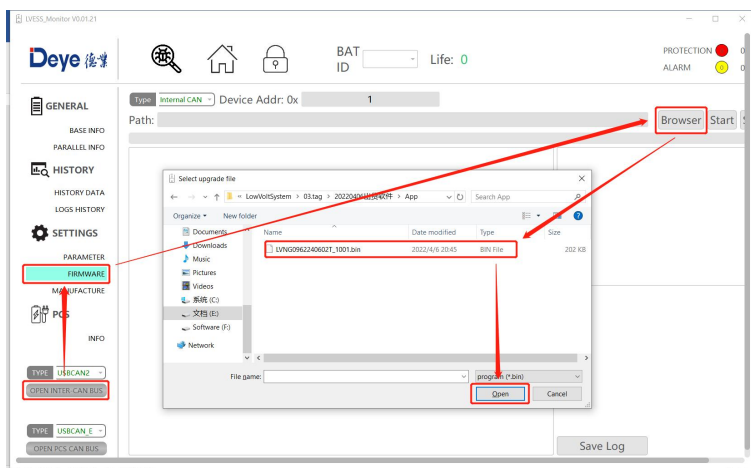

Step 2: Click the "Start".

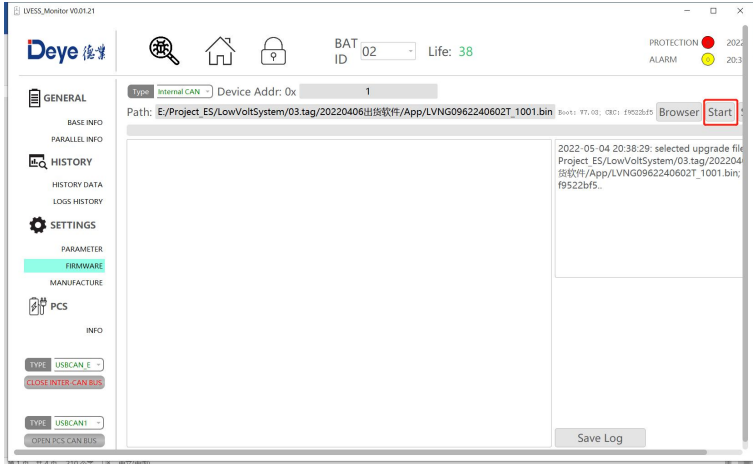

Step 3: If the system upgrades successfully, the “OK” in green will shows up, otherwise the “NG” in red it will be displayed.

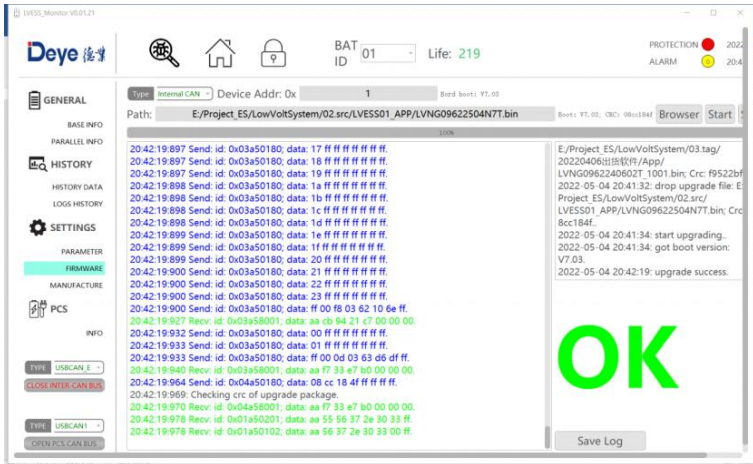

2. Upgrade a single module

Step 1: After successfully connecting to the upper computer, carry out the operation in the order

"Open inter-can bus → Firmware → Browser → Upgrade File → Open".

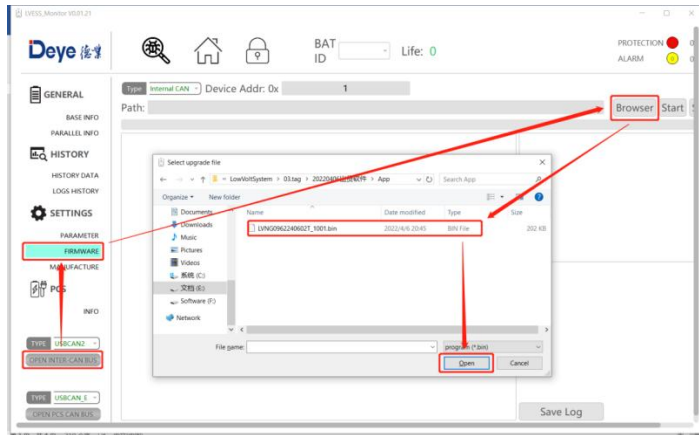

Step 2: Select the upgraded module number. If there is "0x" in "Device Address", enter the corresponding hexadecimal number. For example, if the module No. 29 needs to be updated, you can enter 1D; If there is no "0x" in "Device Address", enter the corresponding decimal number. For example, if the module No. 25 needs to be updated, you can enter 25. After that, click the "Start".

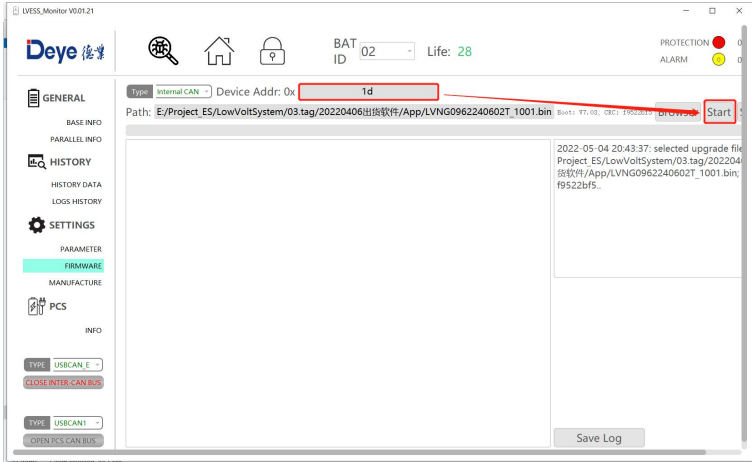

Step 3: If the system upgrades successfully, the “OK” in green will show up, otherwise the “NG” in red it will be displayed.

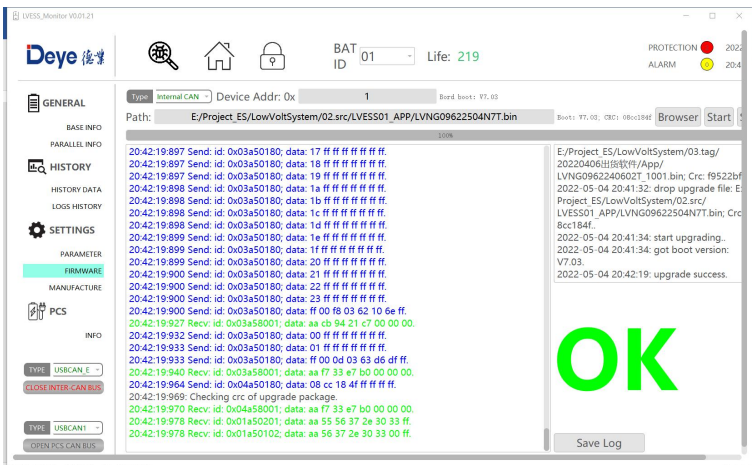

6.4 PCS Upgrade Step

Step1: After logging in the website [DeyeCloud](#), enter the account number and password.

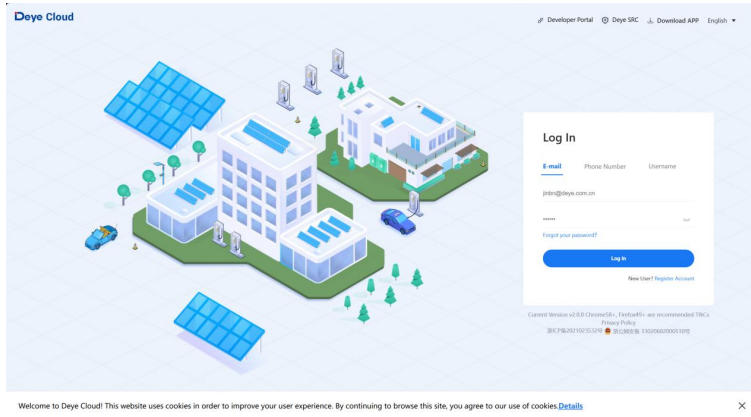

Step2. After clicking the “Device list” and the “Logger”, enter the collector serial number to find the target collector.

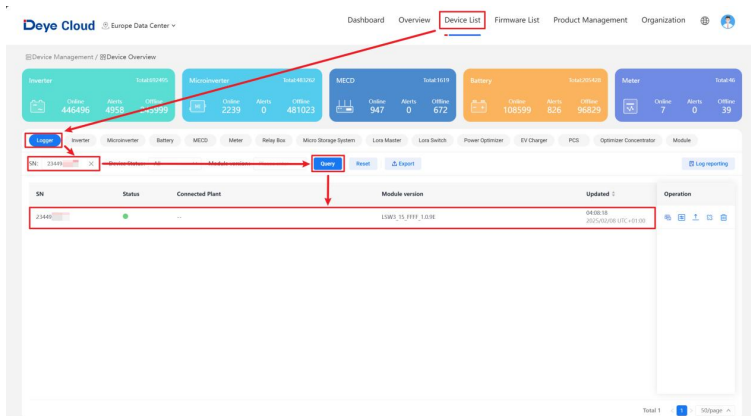

Step3: Click the “Architecture” to choose your target device and then click the “↑”.

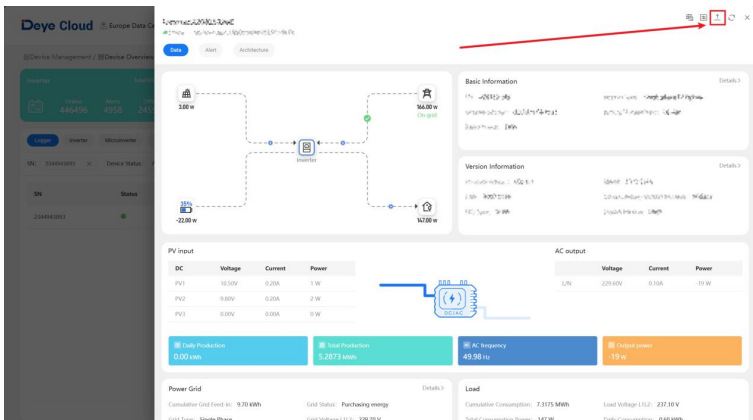
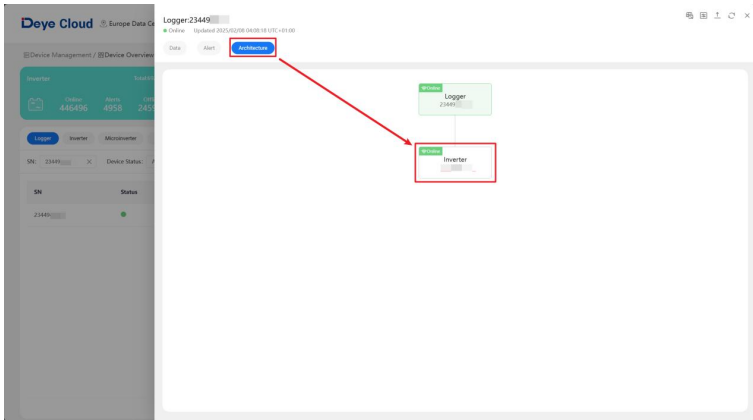

Step 4: Select the "Battery" for the firmware type and the firmware version provided by the technician, and then click the “Confirm” to start the upgrade.

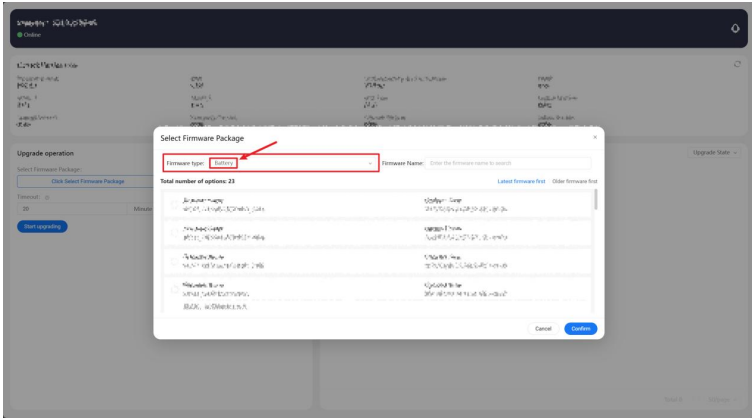

7. Battery Module Storage

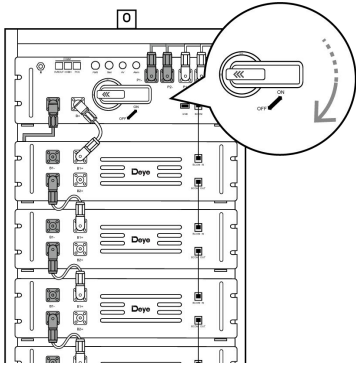

- ① To ensure the battery service life, the storage temperature shall be kept between 0°C~35°C.
- ② The battery shall be cycled at least once every 6 months.
- ③ To minimize self-discharge in a long storage period, turn the circuit breaker handle to “OFF” position.

8. Disposal

For details related to the disposal of battery modules, please contact us. Service Hotline: +86 0574 8612 0560, Email: service-ess@deye.com.cn. For more information, please visit <http://deyeess.com>.

Observe applicable regulations on waste battery disposal. Immediately stop the use of damaged batteries. Please contact your installer or sales partner before disposal. Ensure that the battery is not exposed to moisture or direct sunlight.



Attention:

1. Do not dispose of batteries and rechargeable batteries as domestic waste!
You are legally obliged to return used batteries and rechargeable batteries.
2. Waste batteries may contain pollutants that can damage the environment or your health if improperly stored or handled.
3. Batteries also contain iron, lithium and other important raw materials, which can be recycled.

For more information, please visit <http://www.deyeess.com>. Do not dispose of batteries as household waste!



9. Appendix

9.1 System Circuit diagram

- Battery positive line
- Battery negative line
- - - - - Communication line

